

User Manual

RISHABH 6012...6016

TRMS Digital Multimeter



Model

Functions/Features	6012	6013	6015	6016
Voltage VDC (Ri>9MΩ)	•	•	•	•
Voltage VAC TRMS (Ri>9MΩ)	•	•	•	•
Voltage LoZ VAC TRMS (Ri=1MΩ)		•	•	•
Voltage VAC TRMS (Ri>9MΩ) LPF 1kHz		•	•	•
Voltage LoZ VAC TRMS (Ri=1MΩ) LPF 1kHz		•	•	•
Voltage VACDC (Ri>9MΩ)	•	•	•	•
High impedance, high bandwidth mV measurement	600mV	60mV/ 600mV	60mV/600mV	60mV/600mV
Bandwidth VAC & mV ACDC	10kHz	10kHz	10kHz	100 kHz
Frequency (Hz) Measurement			•	•
Duty cycle %				
Voltage level measurement dB,dBu,dBm		•	•	•
Resistance	•	•	•	•
Conductance measurement	•	•	•	•
Continuity test (I const = 1 mA)	•	•	•	•
Diode measurement (I const = 1 mA)	•	•	•	•
Temperature measurement (TYP J,TYP K)		•	•	•
Temperature measurement (PT100,PT1000)	•		•	•
Capacitance measurement			•	•
Current ADC	600mA	6 A/16 A (20 A)	600 μA/6 mA 60 mA/600 mA 6 A/10 A (16 A)	600 μA/6 mA 60 mA/600 mA 6 A/10 A (16 A)
Current AAC+DC TRMS				
Current AAC TRMS				
Bandwidth @ AAC+DC or AAC 10 kHz	•	•	•	•
Measurement with Clamp Sensor	•	•	•	•
Data Logging (upto 32000 readings) / Viewing Function			•	•
Protective rubber holster	•	•	•	•
Fuse 16A/ 1000V	1.6A		•	•
0-20mA/ 4-20mA percentage scale			•	•
Square wave Out			•	•
Self battery voltage measurement	•	•	•	•
MIN/MAX/AVG and Auto Hold functions	•	•	•	•
Dangerous contact voltage indication	•	•	•	•
REL/Zero function	•	•	•	•
USB IR-interface	Optional			
External power supply adapter				
Measuring Category	1000 V CAT III 600 V CAT IV	1000 V CAT I 600V CAT II	1000 V CAT III 600 V CAT IV	1000 V CAT III 600 V CAT IV

Table of Contents

Contents	Page
1. Safety Features and Precaution.....	1
1.1 Safety Information.....	1
1.2 Warnings.....	2
1.3 Cautions.....	3
1.4 Symbols.....	4
2. Operating Overview.....	5
3. Initializing Start-Up.....	9
3.1 Inserting Battery.....	9
3.2 Connecting the Power Adapter.....	9
3.3 Switching the Multimeter ON.....	9
3.4 Initial Settings.....	10
3.5 Switching the Multimeter OFF.....	11
3.6 Backlit Function.....	12
4. Understanding Control Functions.....	13
4.1 Function Selection using Knob.....	13
4.2 Automatic Range Selection.....	14
4.3 Manual Range Selection.....	15
4.4 Relative/ Zero Function.....	17
4.5 Auto Hold Function.....	19
4.6 Min/Max/Avg Function.....	21
5. Making Measurements.....	23
5.1 Voltage Measurements.....	23
5.2 mV(DC or ACDC)/Hz/Duty Cycle Measurement.....	31
5.3 Resistance Measurement.....	33
5.4 Diode or Continuity Testing.....	34
5.5 Temperature Measurement.....	35
5.6 Capacitance Measurement.....	37
5.7 Square Wave Out Function.....	38
5.8 Current Measurement(mA,A).....	39
6. Menu.....	45
6.1 List of all Parameter.....	46
6.2 Querying Parameter.....	49
6.3 Entering Parameter.....	49
6.4 Parameter.....	51

Table of Contents

7. Technical Data.....	55
7.1 Voltage.....	55
7.2 Reference Condition for Accuracy.....	55
7.3 Frequency Duty Cycle.....	56
7.4 Ampere.....	56
7.5 Resistance, Diode, Continuity.....	57
7.6 Temperature.....	57
7.7 Capacitance.....	58
7.8 Influence Error.....	58
7.9 Square Wave Output.....	58
7.10 Influence Quantity.....	59
7.11 Applicable Regulations & Standards.....	59
7.12 Environmental Conditions.....	59
7.13 Crest Factor.....	60
7.14 Internal Clock.....	60
7.15 Mechanical Design.....	60
8. Interface Option.....	61
8.1 Communication.....	61
9. Maintenance.....	62
9.1 Display - Error Message.....	62
9.2 Battery.....	62
9.3 Fuse.....	63
9.4 Case.....	64
10. Accessories.....	65
10.1 General Information.....	65
10.2 DC Jack Power Supply.....	65
10.3 IR to USB.....	65

Safety Features & Precaution

1. Safety Features and Precaution

You have selected an instrument which provides you with a high level of safety.

The TRMS digital multimeter has been manufactured and tested in accordance with the following safety regulations:

IEC 61010–1:2010.

When used for its intended purpose, safety of the operator, as well as that of the instrument, is assured. Their safety is however not guaranteed, if the instrument is used improperly or handled carelessly. In order to maintain flawless technical safety conditions, and to assure safe use, it is imperative that you read the operating instructions thoroughly and carefully before placing your instrument into service, and that you follow all instructions contained therein.

The multimeter is equipped with an automatic socket blocking mechanism for your safety, and in order to safeguard your instrument. This mechanism is linked to the rotary switch and only allows access to those jacks which are actually required for the selected function. It also prevents the user from turning the rotary switch to impermissible functions after the measurement cables have already been plugged in.

1.1 Safety Information

Safety Standard	: IEC 61010-1:2010
Safety Class	: II
Pollution Degree	: 2
Immunity	: IEC 61000-4-2: 8KV Atmosphere Discharge 4KV Contact Discharge
IP for water and dust	: IEC 60529 Instruments : IP 50, Connector Socket : IP20
Test & Procedure	: IS 13875
DMM 6012, DMM 6015, DMM 6016	
Installation Category	: 1000V CAT III / 600V CAT IV
High Voltage Test	: 7.4KV

Safety Features & Precaution

DMM 6013

Special device for measurements at current transformers without Fuse in the electrical circuit.

Installation Category : 1000V CAT I / 600V CAT II

High Voltage Test : 3.5kV

1.2 Warnings

To avoid possible electric shock or personal injury, follow these guidelines:

- Use this Meter only as specified in this manual or the protection provided by the Meter might be impaired.
- Do not use the Meter if it is damaged. Before you use the Meter, inspect the case. Look for cracks or missing plastic. Pay particular attention to the insulation surrounding the connectors.
- Make sure the battery / Fuse door is closed and latched before operating the Meter.
- Remove test leads from the Meter before opening the battery / fuse door.
- Inspect the test leads for damaged insulation or exposed metal. Check the test leads for continuity. Replace damaged test leads before you use the Meter.
- Do not apply more than the rated voltage, as marked on the Meter, between the terminals or between any terminal and earth ground.
- Never operate the Meter with the cover removed or the case open.
- Use caution when working with voltages above 30 VAC RMS, 42 V ac peak, or 60 VDC. These voltages pose a shock hazard. Meter provides indication for hazardous voltage above 35 VAC RMS 50/60 Hz and 50 VDC.
- Use only the replacement fuses specified by the manual.
- Use the proper terminals, function, and range for measurements.
- When measuring current, turn off circuit power before connecting the Meter in the circuit. Remember to place the Meter in series with the circuit.
- When making electrical connections, connect the common test lead before connecting the live test lead; when disconnecting,

Safety Features & Precaution

- disconnect the live test lead before disconnecting the test lead.
- Do not use the Meter if it operates abnormally. Protection may be impaired. When in doubt, have the Meter serviced.
- Do not operate the Meter around explosive gas, vapor, or dust.
- Use only 1.5 V AA batteries, properly installed in the Meter case, to power the Meter.
- When servicing the Meter, use only specified replacement parts.
- When using probes, keep fingers behind the finger guards on the probes.
- Do not use the Low Pass Filter option to verify the presence of hazardous voltages. Voltages greater than what is indicated may be present. First, make a voltage measurement without the filter to detect the possible presence of hazardous voltage. Then select the filter function.
- Only use test leads that have the same voltage, category, and ampere ratings as the meter and that have been approved by a safety agency.
- Use proper protective equipment, as required by local or national authorities when working in hazardous areas.
- Comply with local and national safety requirements when working in hazardous locations

1.3 Cautions







To avoid possible damage to the Meter or to the equipment under test, follow these guidelines:

- Disconnect circuit power and discharge all high-voltage capacitors before testing resistance, continuity, diodes, or capacitance.
- Use the proper terminals, function, and range for all measurements
- Do not remove batteries while the Meter is turned on or a signal is applied to the Meter's input jacks.
- Before measuring current, check the Meter's fuses.
- Do not use the LPF mode to measure voltages in circuits that could be damaged by this mode's low impedance.

Safety Features & Precaution

1.4 Symbols

Table 1 lists and describes the symbols used on the Meter and in this manual.

Symbol	Description	Symbol	Description
	AC (Alternating Current or Voltage)		DC (Direct Current or Voltage)
	Warning concerning a point of danger (Refer Manual)		Earth (ground) terminal
	Double or reinforced insulation	CAT II	Measurements in electrical circuits which are electrically connected to the low-voltage mains: with plugs, e.g. at home, in the office or laboratory etc.
CAT III	Measurements in building installations: stationary power consumers, distributor terminals, devices connected permanently to the distributor	CAT IV	Measurements at power sources for low-voltage installations: meters, mains terminals, primary overvoltage protection devices
	Fuse		Hazardous Voltage

Operating Overview

2. Operating Overview

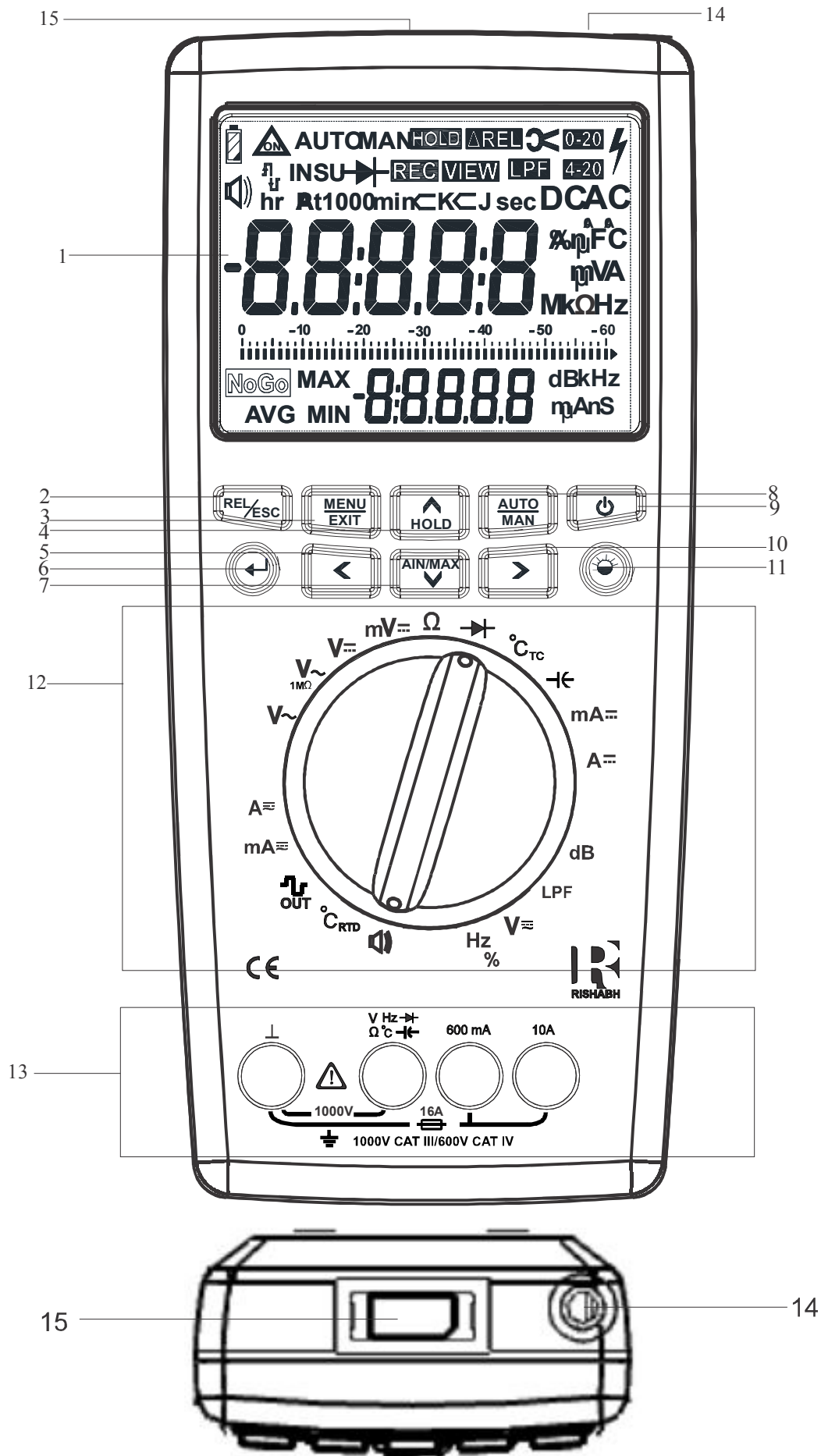

Operating Overview

1. Display LCD (*Refer The display at a glance*)
2. REL / ESC
 - REL: Push Button to switch on/ off Relative Function
 - ESC: Menu mode Exit current menu level, return to higher level, exit parameter configuration without saving data.
3. Push Button to enter the menu or to exit at any point from menu
4. HOLD / Up Arrow
 - HOLD: Push Button to switch on/ off Auto- Hold Function
 - Up Arrow: To increment the value or to change the menu level
5. Left Arrow:
 - Normal Use: For long press of push button, meter shows Battery Voltage
 - Menu Use: Move value to be set, selection pointer to left
6. Function / Enter key
 - Function key: multi-function (sub-function selection) key
 - Enter key: In menu, select / confirm the setting
7. Min / Max / Down Arrow
 - Min/Max/Avg: Push Button to select min/max/avg function
 - Down Arrow: To decrement the value or to change the menu level
8. AUTO / MAN: Push Button to select Automatic or Manual measuring range
9. Push Button to switch on/off Meter
10. Right Arrow
 - Menu Use: Move data selection pointer to right
 - Nogo Use: View the Limits and condition of nogo function
11. Push Button to switch on / off Backlit
12. Rotary switch for measuring functions selection
13. Terminal sockets with automatic blocking system
14. DC Jack Power Supply 5V,1A (Input)
15. Socket for Infrared Communication (IR to USB Adapter)

Operating Overview

The display at a glance

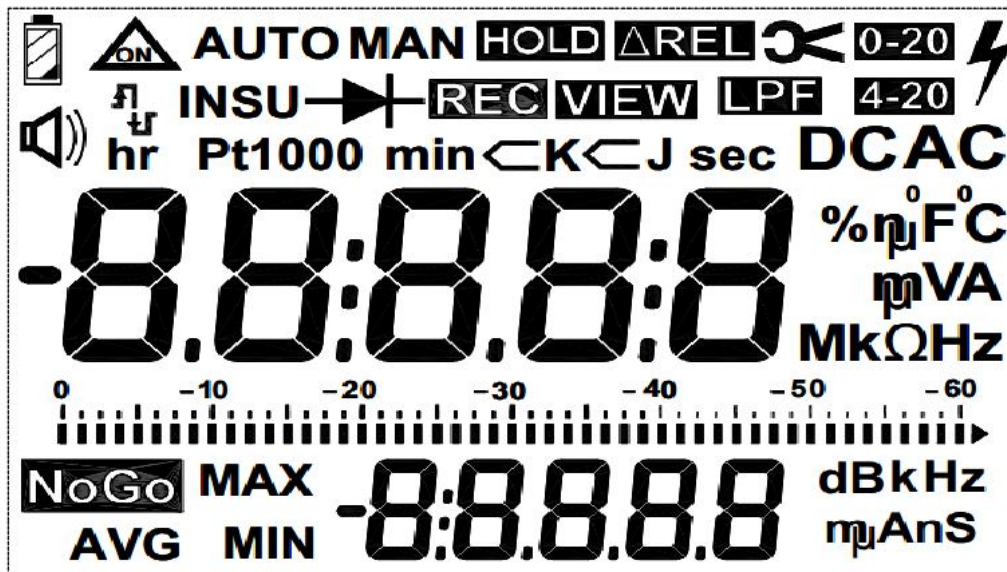

Symbol	Description	Symbol	Description
	Low Battery Indication		Continuous Meter on
AUTO	Auto Range	MAN	Manual Range Selection
HOLD	Auto- Hold Enabled	REL	Relative Measurement with reference to offset
0-20	Percentage scale readout proportional to DC 0–20 mA	4-20	Percentage scale readout proportional to DC 4–20 mA
	Standard Clamp Selected		Presence of Hazardous Voltage
	Audible Continuity	LPF	Low pass filter Cut-off Frequency 1kHz
REC	Memory Data-Logging Indication	VIEW	View Logged Data
	Square wave output		Diode
CK	Thermocouple k Type	CJ	Thermocouple J Type

Operating Overview

Symbol	Description	Symbol	Description
NoGo	Go - NoGo Function	MIN	Dynamic Recording mode: Minimum value on secondary display
MAX	Dynamic Recording mode: Maximum value on secondary display	AVG	Dynamic Recording mode: Average value on secondary display
dB	Decibel Measurement	hr	Time: Hour Display
min	Time: Minute Display	sec	Time: Second Display
DC	Direct Current	AC	Alternating Current
°C	Temperature measurement in Degree Centigrade unit	°F	Temperature measurement in Fahrenheit unit
V	Voltage	A	Ampere (Current)
%	Duty Cycle or Scale in percentage	INSU	Not used

Analog

Display: LCD scale with bar graph or pointer, depending on the selected parameter setting

Scaling: 2 bar/pointer corresponds to 2500 counts at the digital display

Over range Display (Digital): By triangle “▶”

Polarity Display: With automatic switching

Sample rate (Digital): 10 measurements/sec and display refresh

Digital

Display: 7-segment characters

Character Height: Main Display - 12.88mm, Sub Display - 7.37mm

Resolution: 60,000 counts

Overflow Display: “OL” is displayed

Polarity: “-” (minus) is displayed if plus pole is connected to “⊥”

Measuring Rate: 10 measurement/sec with the Min-Max function except for the capacitance, frequency and duty cycle measuring Function

Refresh Rate: 4 times/ sec

Initializing Start-Up

3. Initializing Start-Up

3.1 Inserting Battery

Insert the batteries provided with the DMM with polarities as directed on the battery cover. (*Refer maintenance of Battery 9.2.*)

Attention!

Do not replace or remove the batteries while meter is connected to any measuring circuit.

3.2 Connecting the Power Adapter

DMM 601X series is equipped with a DC jack facility and hence can be turned on by power adapter available as an additional accessory. When adapter is inserted in to the DMM, battery operation is automatically switched off, hence no need to remove the batteries while using power adapter.

If power adapter is switched off, DMM automatically switches to battery operation

Attention!

Do not use any power adapter other than the one provided as an additional accessory with 601X series.

3.3 Switching the Multimeter ON

In order to turn on the DMM press  **ON/OFF Key** until the display appears. As long as the key is held depressed all the segment of the LCD will remain on, this is also called as LCD test. (*Refer The display at a glance for LCD symbols description*)

Pressing  **ON/OFF key** again will turn off the DMM.

Note

Electrostatic discharge or high frequency interference may cause

Initializing Start-Up

undesired display or may stop the measurement. For recovery disconnect meter from measuring circuit, turn off the meter and back on again, if the problem remains, then remove and reinsert the batteries of the DMM.

3.4 Initial Settings

When ever the batteries are removed/replaced/reinserted in to the meter, the date and time are reset to default.

The default date is 01/01/2001 and default time is 00:00:00 hrs. When ever date is reset to default, the display will notify the user to set date and time every time the meter turns on. Ensure the date and time are set in the multimeter for internal data logging and PC communication.

(Refer Menu 6.3 for setting date and time)



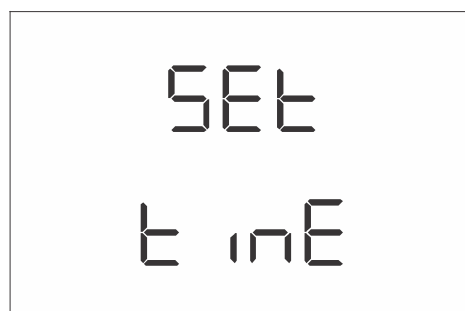

Press Up
Key to
Set Time



3.5 Switching the Multimeter OFF

Meter can be turned off manually by either of the following ways:

1. Manual Shutdown(ON/OFF Key)

Press and release action on the  ON/OFF key when meter is turned ON, will switch off the meter. The DMM freezes all the data currently on the display until the  ON/OFF key is depressed. Once the  ON/OFF key is released a brief acoustic sound is generated in order to acknowledge the key press.

2. Automatic Shutdown:

The instruments is switched off automatically if the measured reading remains in single range(i.e range change doesn't occur) for more than the time set in AUTO OFF function of the Settings Parameter. The Default time for Auto OFF function is 10 Minutes and can be set through 5 minutes to 60 minutes.(Refer Menu 6.3 for setting the Auto Off function)

The AUTO OFF timer is reset/disabled in the following events:

- A) Resets if Rotary knob is rotated (i.e measuring function is changed).
- B) Resets if any of the key is pressed and acknowledged with a beep.
- C) Resets whenever a byte is transmitted from meter to the PC or if data logging is enabled. (i.e PC communication is going on)
- D) Disabled if the meter is put in the Continuous ON mode from settings.(Refer Menu 6.3 for setting the Auto Off function)

Note

- The Function like Diode, Continuity, Duty Cycle, Thermocouple, RTD, etc. will switch off automatically after the default / set time, if not in continuous on mode.

Initializing Start-Up

3.6 Backlit Function

For measurement in low light or dark surroundings, backlit of the meter can be turned on to increase the visibility of the readings. To do so Press  backlit key once, a beep sound is produced as an acknowledgment and the display gets illuminated.

To turn off the illumination press the  backlit key again, a brief sound is produced and the illumination will be turned off.

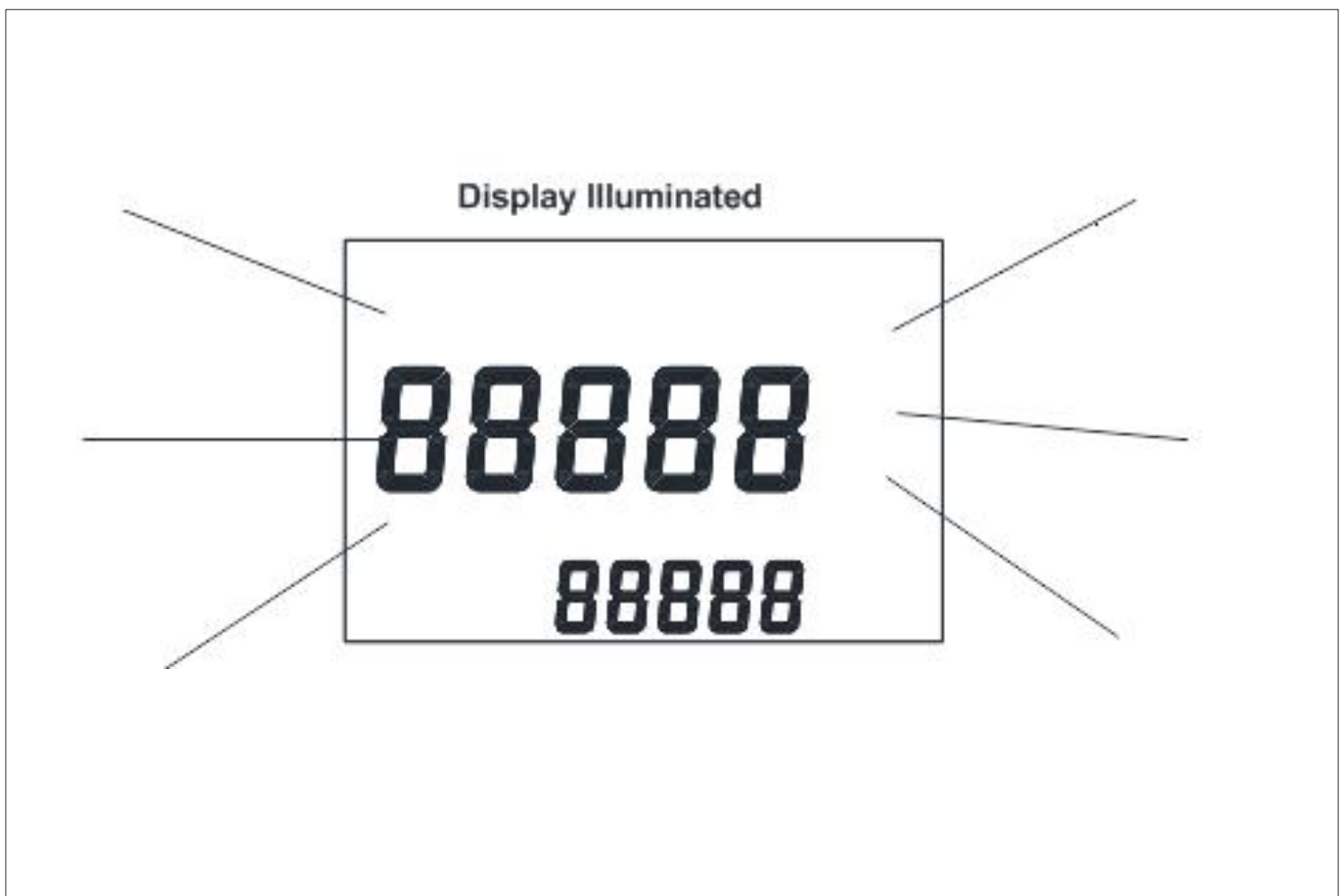

Understanding Control Functions

4. Understanding Control Functions

The chapter gives details about function selection and range selection functions, Auto Hold function, REL/Zero function and MIN/MAX/AVG functions.

4.1 Function Selection using Knob

Any of the functions given on the front panel of the DMM can be selected using knob selector switch. The function selector switch is coupled with the Automatic terminal Blocking System (ABS) which allows access only to two correct sockets for each function. Prior to switching to the "mA" or "A" functions or from the "mA" or "A" functions, remove the test lead from the corresponding socket. When the test leads are plugged-in, the terminal blocking systems prevents accidental switching to non permissible functions. (*Refer Measuring functions for information of available functions*).

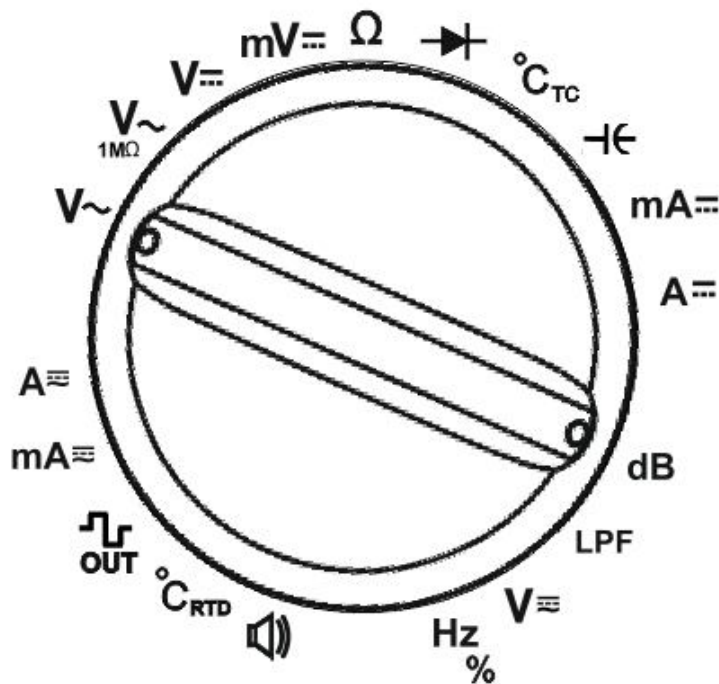

Fig: Knob Selector switch

Understanding Control Functions

4.2 Automatic Range Selection

The DMM 601X series automatically selects the best possible range and hence best resolution for all the measuring functions depending upon the applied input. The auto range selection is disabled for LPF function, diode, continuity, temperature, Duty and square wave out function. The Auto Range function is acknowledged by a **AUTO** symbol on LCD. The ranging for secondary display functions like Hz in VAC or mV ACDC, dB, dBu, dBm, time in frequency, conductance in resistance, reference temperature in thermocouple are all auto selected and cannot be manually selected.

By default the meter enters in auto mode when ever the meter is switched ON.

4.2.1 Auto Ranging Function

The multimeter is switched automatically to the next higher range at $(63000D + 1D)$ and to the next lower range at $(5800D - 1D)$ except for 40Mohm range where the multimeter switches to the next lower range at $(580D - 1D)$.

In capacitance mode multimeter switches to next higher range at $(1100D + 1D)$ and to the next lower range at $(900D - 1D)$.

In conductance and Time in Frequency mode multimeter switches to next higher range at $(10000 + 1D)$ and to next lower range at $(10000 - 1D)$

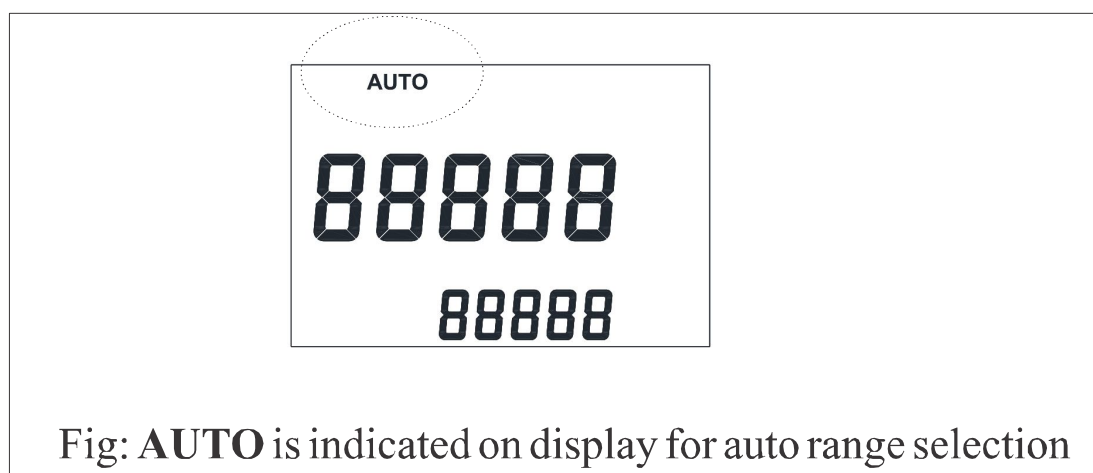





Fig: **AUTO** is indicated on display for auto range selection

Understanding Control Functions

4.3 Manual Range Selection

Manual range selection for all measuring functions can be selected by pressing the  **AUTO/MAN** key. User can scan through all the possible ranges for the selected function by pressing  **AUTO/MAN** key repeatedly.

The manual range selection is acknowledged by **MAN** symbol on LCD.

Once the multimeter enters the manual mode it cannot select the range for applied input automatically. Reactivation of auto mode is possible either by pressing the  **AUTO/MAN** key for more than 1s (long press) or by changing the measuring function using knob selector switch or function key.

The range switching sequence for DMM 601X series is as shown below in the chart:

Range Switching Sequence		
Auto/Man	Function	Range
Short Press	Manual Mode is on and Measuring Range is Fixed	
Short Press	Voltage (VAC10M, VAC1M, VACDC, VDC)	6.0000V → 60.000V → 600.00V → 1000.0V → 6.0000V
	mV (DC, ACDC)	60.000mV → 600.00mV → 60.000mV
	Hz	600.00Hz → 6.0000kHz → 60.000kHz → 600.00kHz → 1.0000MHz → 600.00Hz
	Resistance	600.00Ω → 6.0000kΩ → 60.000kΩ → 600.00kΩ → 6.000MΩ → 40.00MΩ → 600.00Ω
	Capacitance	10.00nF → 100.00nF → 1.000μF → 10.00μF → 100.0μF → 1000μF → 10.0nF
	mA(DC,AC,ACDC)	600.00μA → 6.0000mA → 60.000mA → 600.00mA → 600.00μA
	A(DC,AC,ACDC)	6.0000A → 10.000A → 6.0000A
Long Press(>1S)	Manual mode is deactivated and Auto range is restored	

Understanding Control Functions

Short Press
range key to
activate manual mode

AUTO
MAN



Short Press
range key to
activate manual mode

AUTO
MAN

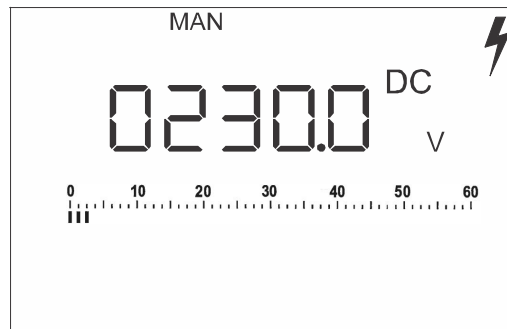

Long Press
range key to
return to Auto mode

AUTO
MAN

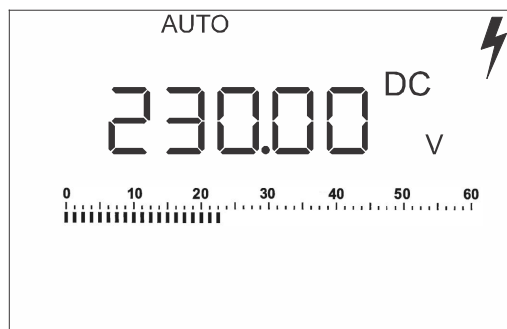



Fig: Manual Range Selection

4.4 Relative/ Zero Function

4.4.1 Relative mode operation

To use relative mode short press  **REL/ESC** key once. When the meter enters in to relative mode a **REL** symbol is shown on the display. Meter automatically switches to manual mode and current measuring range is selected as the measurement range once relative mode is activated.

The reference value is shown on the sub display. Multimeter mathematically subtracts reference value from actual applied input and the resultant is displayed on the main display.

To set the reference value plug the cables to the multimeter and measure the reference value. By pressing, the  **REL/ESC** key, a beep sound is produced and **REL** symbol will appear on the main display as an acknowledgment.

4.4.2 Zero Function

Zero function is similar to the relative function explained above. To use zero function plug the cables to the multimeter :

- Short the leads of the multimeter for DCmV, Resistance or DCuA and briefly press  **REL/ESC** key.
- In capacitance mode with probes connected, press REL/ESC key. Meter enters in to manual mode and **REL** symbol is indicated on the main display. The reference value for zero is indicated on the sub display. Meter when in REL mode will subtracts the zero reference value from the applied input and the resultant is displayed on the main display.

To exit from REL/Zero Function, short press  **REL/ESC** key again, a beep sound is acknowledged.

Note

- Other control functions like Hold, Min/Max/Avg are disabled in REL mode

Understanding Control Functions

- Negative sign may appear in resistance or capacitance or AC quantities when **REL/ZERO** is activated.
- When “**OL**” is being displayed on the meter, **REL** function cannot be activated but can be deactivated if already active.
- Measurement functions like diode & continuity doesn't support **REL/ZERO** function.
- Pressing  **AUTO/MAN** key for range change or change of measuring function using knob selector or pressing **Function** Key will automatically deactivate the **REL** function.

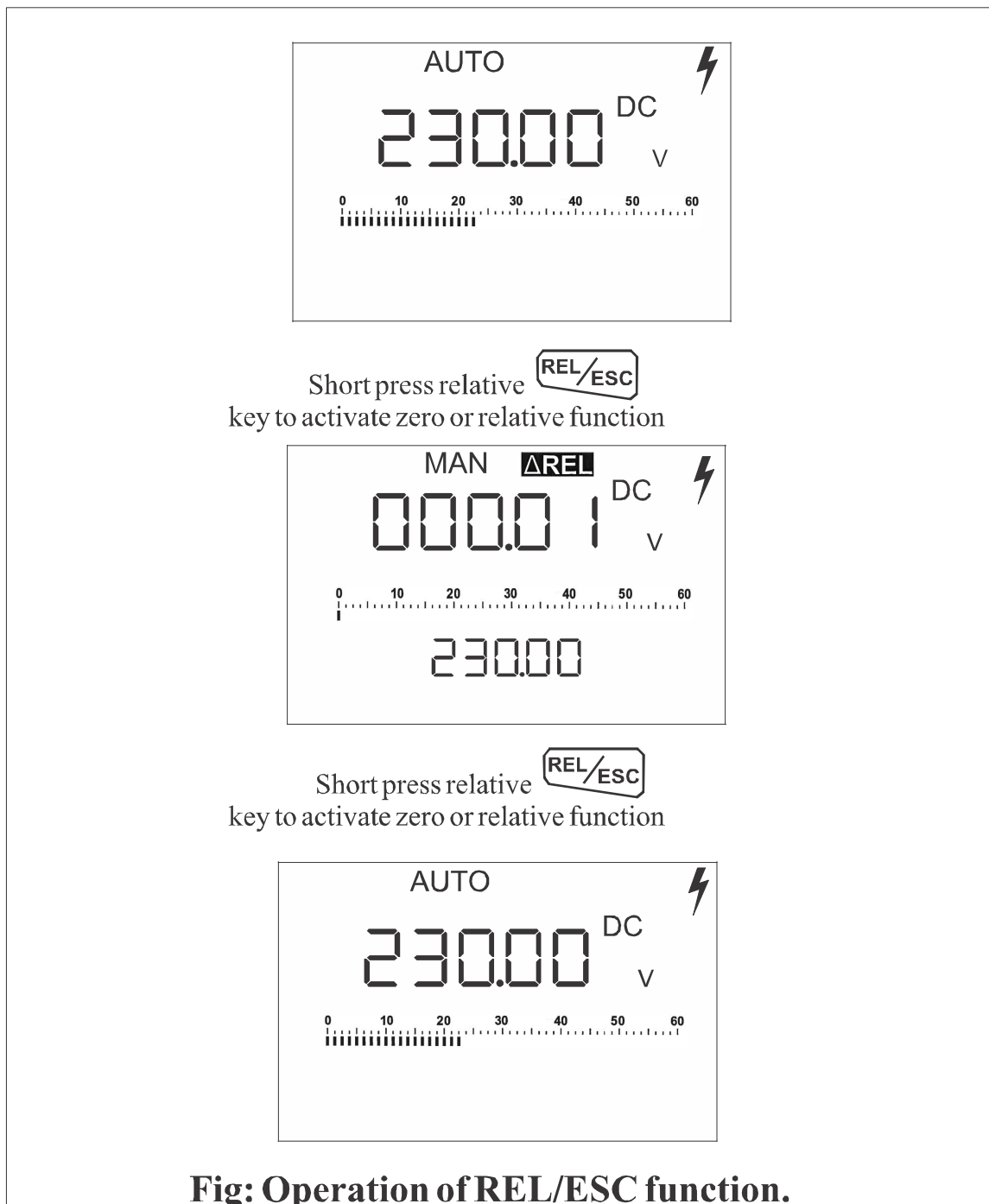

Understanding Control Functions

4.5 Auto Hold Function

With auto hold function user can freeze the applied measuring input. The frozen value is displayed on the sub display of the meter.

Auto hold function is different than from a normal hold function in the sense that auto hold detects the applied input and compares it with thresholds (*Refer Table Auto Hold Measuring Signal*) and then holds the value.

Auto hold function is of particular importance where the measurement with the probes requires full attention. For e.g. Whenever doing a measurement on height, or in complex panel areas where focus has to be on the probes than the display, there auto hold function can ease this difficulty.



4.5.1 Auto Hold Operation

To use auto hold function connect the probes to the multimeter, and select the measuring function. Use range key to select the measurement range, this is of importance because meter enters in manual mode once auto hold function is activated. Short Press  **UP/HOLD** Key once, a **HOLD** symbol will be indicated on the main display and a beep sound is produced as an acknowledgment to indicate auto hold function is activated. Now connect the probes to the measurement circuit, once meter starts measuring the applied input, it compares the applied input with the below listed thresholds. If the applied input crosses the threshold, the measured reading gets Hold on the sub display of the meter. Now even if the probes are disconnected from the measuring circuit, the Hold value still remains on the sub display of the meter for the user's analysis.

To deactivate the Hold function short press  **UP/HOLD** key, a beep sound is produced and **HOLD** symbol disappears from main display. After deactivation of hold DMM reconfigures itself.

Understanding Control Functions

Note

- Other control functions like REL/ZERO, Min/Max/Avg are disabled when **HOLD** is activated.
- The Hold function is reactivated when the range is changed using  **AUTO/MAN** key.
- The change of measuring function using knob selector or **Function Key**  will automatically deactivate the **HOLD** function.
- Hold function is disabled for temperature function.



Key Press	Measuring Function	Measuring Signal
Short (Enable)	V, A, Hz, dB, F, %	> 6% of Overload
	 , Ω	< Overload
Reactivate	V, A, Hz, dB, F, %	< 6% of Overload
	 , Ω	= Overload
Short (Disable)	-	-

Table: Auto Hold Measuring Signal

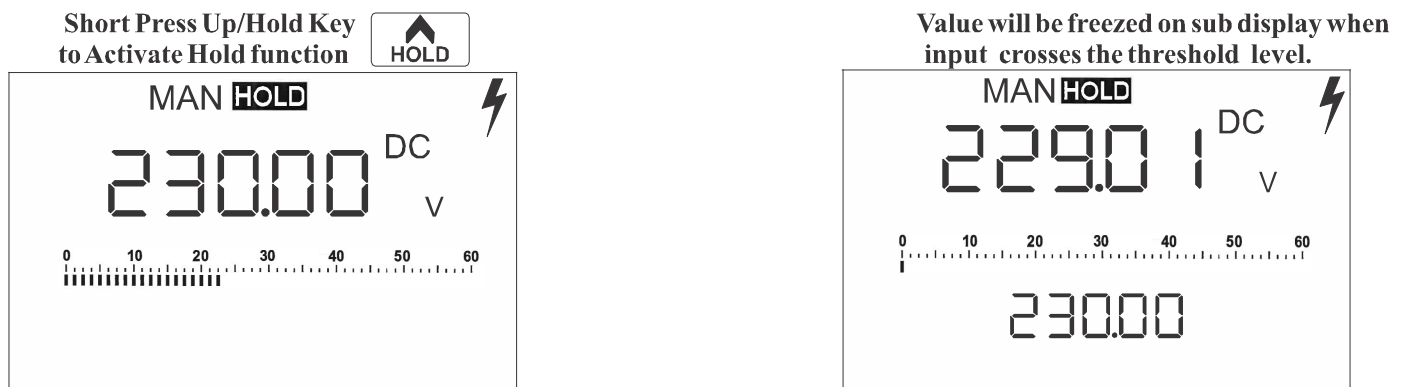

Fig :Auto Hold operation

Understanding Control Functions



4.6 Min/Max/Avg function

Min/Max/Avg function can be seen as a short summary of a long duration test. Min/Max/Avg function is best suitable for recording intermittent readings, recording minimum/maximum or average readings unattended. Min indicates the minimum value observed in the applied input during observation period. Max indicates the maximum value observed in the applied input during observation period. Avg indicates the average result of all the readings except “OL” readings measured during the observation period.

Min/Max/Avg function can be used for application where there is need for measuring power supply variations, unpredictable current levels or finding intermittent system failures.

The average value displayed is arithmetic mean of all the readings taken since the start of the recording, discarding overload display. Average function is useful for smoothing out unstable inputs or calculating averaged current consumption etc.



4.6.1 Activating/Deactivating Min/Max/Avg function

Select the measuring range before activating Min/Max/Avg function. To activate MIN/MAX/AVG function short press **Down/Min/Max/Avg** key . **MIN** symbol will be indicated on the LCD display and a beep sound is generated to acknowledge the key press. The meter records the current display reading and indicates it on the sub display. If the new min/max is detected it will be stored and indicated on the sub display of the meter. To view Max reading short press  **Down/Min/Max/Avg** key again, **MAX** symbol will be indicated on the display and a beep sound is produced to acknowledge the key press. To view averaged reading short press  **Down/Min/Max/Avg** key again, **AVG** symbol will be indicated on the display and a beep sound is produced to acknowledge the key press. Short pressing the **Down/Min/Max/Avg** will again rollover's the screen to min reading.

Understanding Control Functions

To deactivate MIN/MAX/AVG, long press  **Down/Min/Max/Avg** for 1s, multimeter exits from the function and reconfigures itself.

Note

- Other control functions like REL/ZERO or Hold are disabled when **Min/Max/Avg** function is activated.
- The **Min/Max/Avg** function is reactivated when the range is changed using  **AUTO/MAN** key.
- The change of measuring function using knob selector or **Function** key  will deactivate the **Min/Max/Avg** function.
- Min/Max/Avg function is disabled for diode and continuity function.

short press min max key 
to activate min/max/avg function

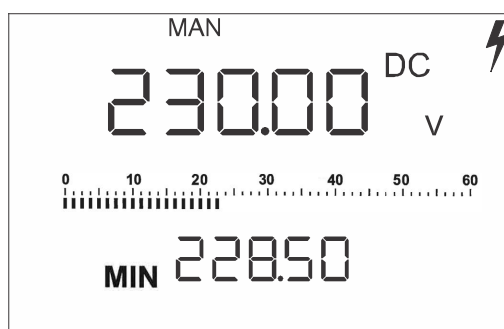

short press min max key 
to scroll down to max reading

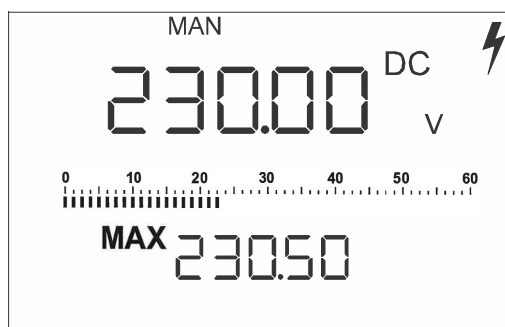

short press min max key 
to scroll down to Average reading

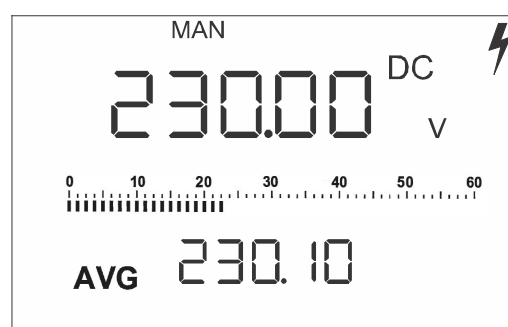

Making Measurements

5. Making Measurements

5.1 Voltage Measurements

Note

- The multimeter should only be operated by the person who understands electrical safety considerations and is able to take necessary precautions.
- **Hazardous voltage** exists anywhere, where the voltages of greater than 35V RMS 50/60 Hz or 50VDC may occur.
- Make sure while doing measurements where hazardous voltage exists , you are accompanied by someone who is capable of rendering resuscitation or first aid in case of electrical accidents.
- While making measurements **don't touch the metallic part of the probes** under any circumstances.
- **Do not measure more than the rated voltage (as marked on the meter) between terminals, or between terminal and earth ground.**
- Be prepared for the occurrence of unexpected voltages at devices under test (e.g. defective devices). For example, voltages across a charged capacitor.
- Additional attention is required when measuring high frequency & high energy waveforms.
- High frequency dangerous voltage spikes are not indicated in low pass filter mode, hence it is recommended to first measure the voltage without LPF mode, for identification of the presence of dangerous voltage.

Making Measurements

- When connecting probes, always connect the common test probe first. When disconnecting probes, always disconnect the live test probe first.

Table for scope of voltage measurement.

Measuring Functions	6012	6013	6015	6016
VAC _{10MΩ} (True RMS AC measurement)	•	•	•	•
VAC _{1MΩ} (True RMS AC measurement) ¹⁾		•	•	•
VAC _{10MΩ} 1KHz Low Pass Filter ²⁾		•	•	•
VAC _{1MΩ} 1KHz Low Pass Filter ²⁾		•	•	•
VAC _{10MΩ} dB measurements		•	•	•
VAC _{1MΩ} dB measurements		•	•	•
V _{DC} & V _{ACDC}	•	•	•	•

1) Input resistance of approx. 1 MΩ. Erroneous displays resulting from capacitive coupling during voltage measurement in power supply systems are reduced to a minimum in this way

2) A 1 kHz low-pass filter can be used in this case, in order to filter out high frequency pulses of greater than 1 kHz, for example when performing measurements at pulsed motor drives.

Making Measurements

5.1.1 Measuring DC and ACDC voltages

- For measuring DC or ACDC voltages select VDC function using knob selector switch.
- Connect the probes to the multimeter & ensure that the black probe is connected to the ground terminal “ \perp ” to avoid the confusion of polarities .
- To select VACDC function press function key once, a beep will be produced and “ACDC” symbol will be indicated on the display.
- To Select VDC function again press function key once more to rollover the function to VDC.

(Refer Technical Data for detailed accuracy and other specifications).

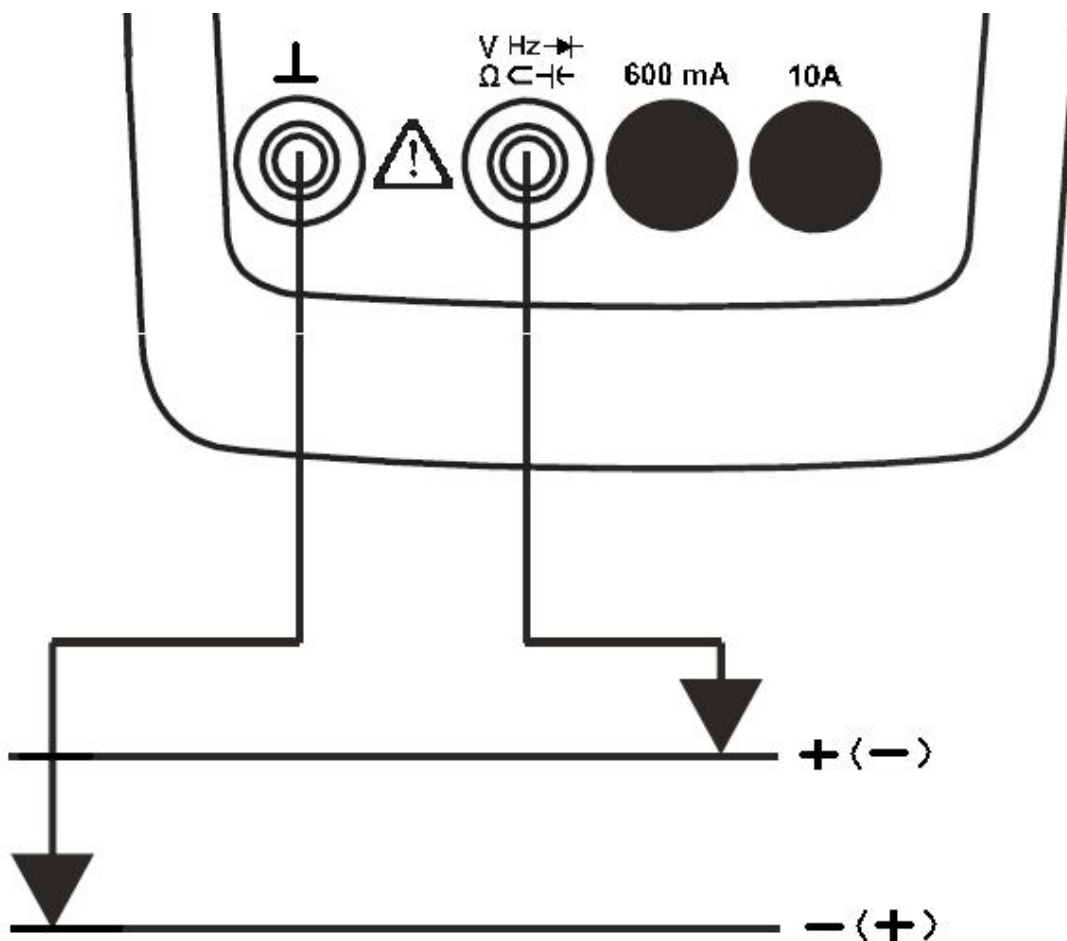

Making Measurements

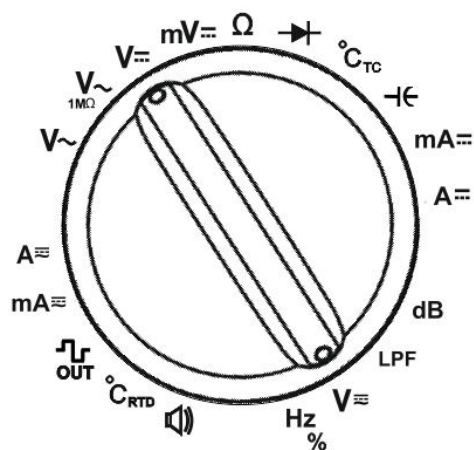
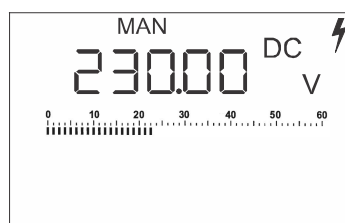
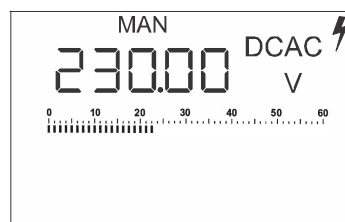

Fig. Select VDC function using knob Selector switch



Short press function key
to select V_{ACDC} function



Hazardous voltage present at terminal are indicated on the display by ⚡

- ⚡ for voltages greater than 35 VAC (RMS) 50/60 Hz & 50V DC

Making Measurements

5.1.2 Measuring Alternating voltages on VAC_{1MΩ} and VAC_{10MΩ}

VAC_{1MΩ} can be used while making measurements at the power supply or inverter. Low impedance measurements help to avoid erroneous display resulting due to the capacitive coupling.

- In order to make measurements in VAC_{1MΩ} and VAC_{10MΩ} keep the knob on VAC_{1MΩ} or VAC_{10MΩ} position respectively.
- Connect the probes to the multimeter & ensure that the black probe is connected to the ground terminal “ ⊥ ” to avoid the confusion of polarities .
- Sub display indicates the frequency of the applied input.

(Refer Technical Data for detailed accuracy and other specifications)

5.1.2.1 Low Pass Filter

DMM 601X series is equipped with a low pass filter with a cutoff frequency of 1kHz. When dealing with modulated PWM output, using a conventional DMMs, makes it difficult to obtain accurate frequency and voltage measurements. Typically the readings obtained will be around 20 to 30% higher than the actual output shown on the VFD's display. Low-pass filters allow only low frequency signals to pass unaltered while attenuating all other signals that are not wanted.

- To select LPF mode, Keep the knob on VAC_{10MΩ} or VAC_{1MΩ} and press function key repeatedly until LPF is shown on the display.
- Sub display indicates the filtered frequency obtained at the output of the filter.
- To exit from LPF mode long press function key, LPF symbol will disappear.

Attention

High frequency dangerous voltage spikes are not indicated, when

Making Measurements

using LPF mode. In order to be able to detect presence of hazardous voltage, make measurements using normal mode first.

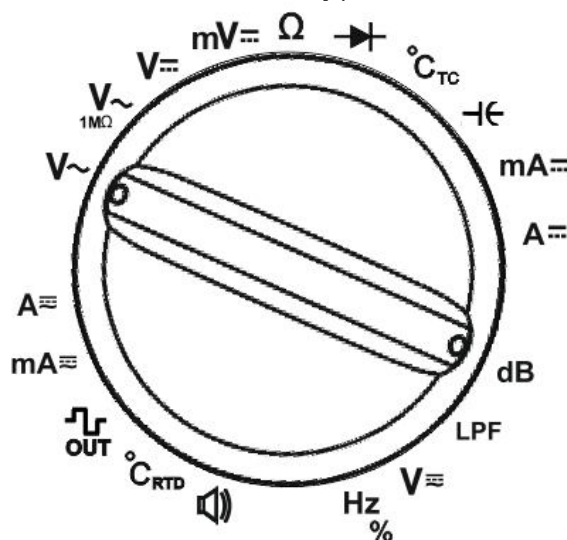
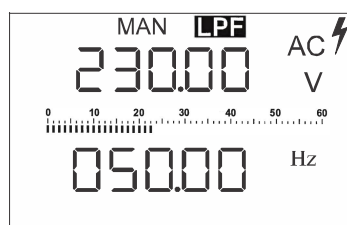
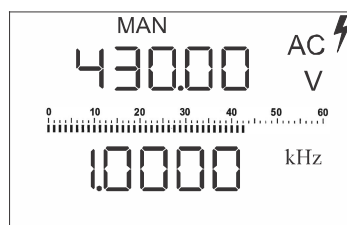
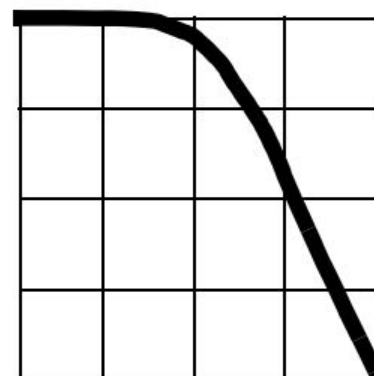

Fig. Select VAC 10MΩ or VAC 1MΩ for LPF Function or dB function



V~ & Filter



Indication of Dangerous Voltage ⚡

The input signal or measuring signal is checked by a voltage comparator for dangerous spikes, because these do not appear at the display when the low-pass filter is used.

At voltages of greater than 35 V AC 50/60 Hz or 50 V DC, a danger symbol appears at the display.

Making Measurements

5.1.2.2 dB Measurements

DMM 601X series facilitates different decibel (dB) measurements like dB, dBu and dBm. The decibel (dB) is a logarithmic way of defining a ratio, where the ratio can be of a voltage, input/output of a sensor or an input/output of a transmitter or receiver. The decibel is a unit of measurements widely used for instrumentation, communication and signals.

Attenuation or amplification of a signal at the output of an amplifier or a two port network system can easily be understood with dB results.

dBV is calculated using the formula :

$$\text{dBV} = 20 \log_{10} (V_{\text{RMS (measured)}})$$

where $V_{\text{RMS (measured)}}$ is the voltage available at the input terminal.

This gives the **dB** relative to 1 volt, regardless of impedance.

dBu (unloaded) is calculated using the formula :

$$\text{dBu} = 20 \log_{10} (V_{\text{RMS (measured)}}/0.7746)$$

where,

$V_{\text{RMS (measured)}}$ is the voltage available at the input terminal.

This is also regardless of impedance but is from a 600 Ω load dissipating 0 dBm (1mW).

dBm is calculated using the formula :

The dBm operation calculates the power delivered to a reference resistance relative to 1mW.

$$\text{dBm} = 10 \log_{10} [(V_{\text{RMS (measured)}})^2 \times 1000 / \text{Reference Impedance}]$$

where,

Reference impedance can be adjusted in between 1 Ω to 9999 Ω . The default setting is 50 Ω . (*Refer 6. Menu for setting of reference resistance for dBm*).

Making Measurements

- To select **dBV** function, keep knob in $VAC_{1M\Omega}$ or $VAC_{10M\Omega}$, Press function key repeatedly until dB symbol appears on sub display.
- To select **dBu** function, keep knob in $VAC_{1M\Omega}$ or $VAC_{10M\Omega}$, Press function key repeatedly until dBu symbol appears on sub display.
- To select **dBm** function, keep knob in $VAC_{1M\Omega}$ or $VAC_{10M\Omega}$, Press function key repeatedly until dBm symbol appears on sub display.
- The resultant dB value are displayed on sub display.
- To exit from any of the dBm functions long press function key for about 1second, dB symbol will disappear from the main screen.

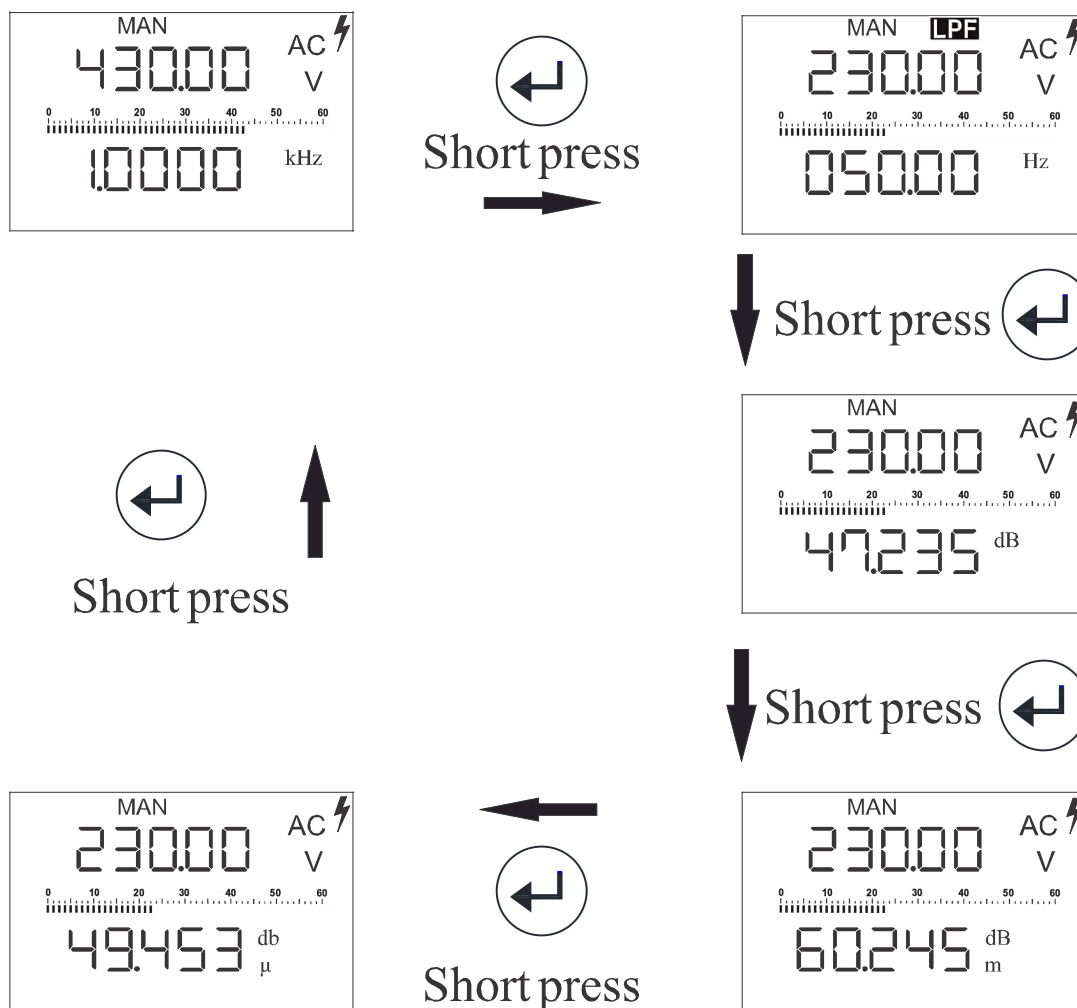

Making Measurements

5.2 mV(DC or ACDC) / Hz / Duty cycle measurement

DMM 601X series provides a high impedance high bandwidth small signal both DC or ACDC measurements. This is ideal for performing measurements on sensor outputs and debugging of transmitter or receiver in communication system.

For **mV_{DC}** measurements,

- Keep the knob on mV_{DC} function, connect the probes to the multimeter & ensure that the black probe is connected to the ground terminal “⊥” to avoid the confusion of polarities .

For **mV_{ACDC}** measurements,

- Keep the knob on mV_{DC} function, press function key until ACDC symbol appears on the main display.
- Sub display indicates the frequency of the applied input.

For **Hz/Duty(%)** measurements,

- Keep the knob on mV_{DC} function, press function key until Hz symbol appears on the main display.
- Sub display indicates the time period of applied waveform.
- For Duty cycle measurement press function key until “ % ” symbol appears on the main display.

Attention

Do not apply signals of voltage greater than 5V_{peak}.

(Refer Technical Data for detailed accuracy and other specifications)

Making Measurements

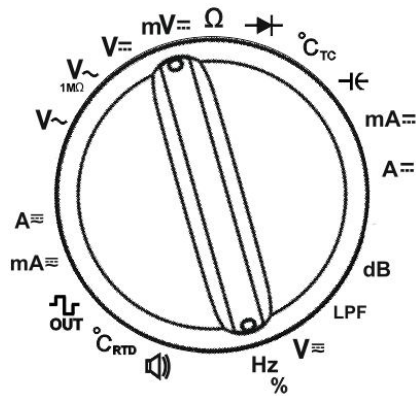
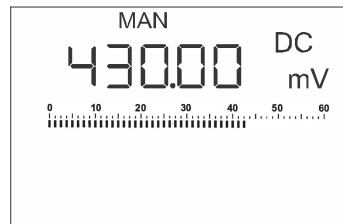
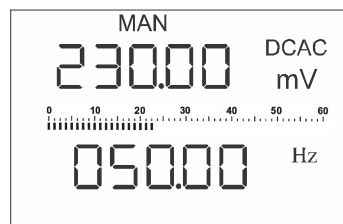

Fig: Select mVDC function using function selector switch



Short Press



Short Press

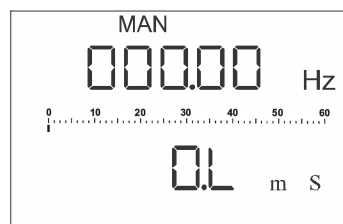
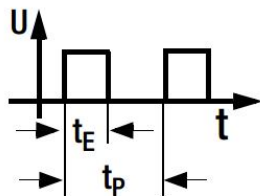

f_p (Pulse Frequency)

t_p (Pulse Period)

Pulse Time Quantities

f_p pulse frequency = $1/t_p$

t_E pulse duration

t_p pulse period

$t_p - t_E$ interpulse period

t_E/t_p pulse or duty cycle



Short Press

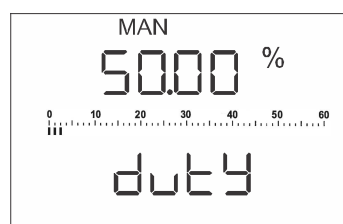

t_E/t_p

Making Measurements

5.3 Resistance (Ω) Measurement

- Keep the knob at Ω (resistance) function, and make the setup as shown in the figure.
- Make sure the resistor to be measured is electrically disconnected, otherwise readings may differ from actual value.
- If at all the resistance is to be measured on board, make sure the board is electrically disconnected.
- In resistance mode subdisplay indicates the conductance value for the measured resistance.

Notes

- For accuracy in 600Ω range use zero balancing, to zero the lead resistance. (*Refer REL/ZERO function*)
- Use short or shielded cable when measuring higher resistance.

(Refer Technical Data for detailed accuracy and other specifications)

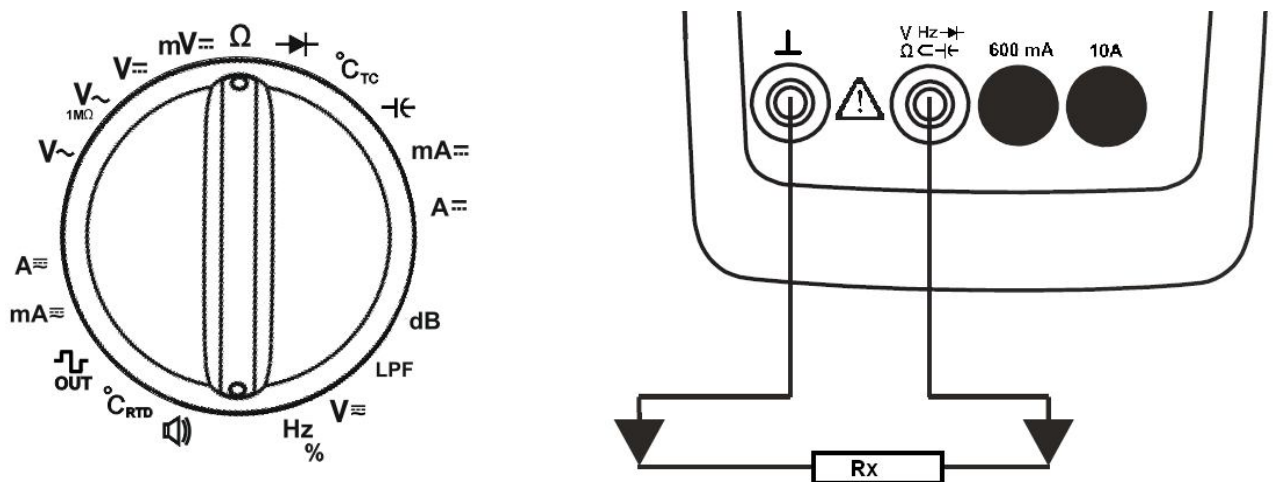
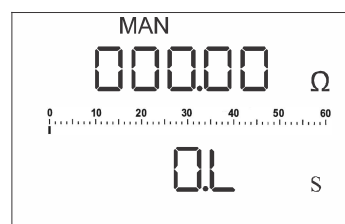

Fig: Select resistance using knob selector function



$$\text{Conductance (Siemens)} = 1/(\text{Resistance})$$

Making Measurements

5.4 Diode \rightarrow or Continuity 🔊 Testing

- To test the diode, or to measure the forward voltage of the diode, keep the knob on Diode function, “ \rightarrow ” symbol appears on the main display, make the set up as shown in the figure.
- Make sure the device under test is electrically disconnected, otherwise the true results can't be guaranteed.
- For short circuit testing press function key when knob is at Diode position. “ Ω ” & “ 🔊 ” symbol appears on the main display. Beep level is the resistance level below which the multimeter gives a beep. DMM 601X series facilitates the adjustments of beep level through $10\ \Omega$ through $90\ \Omega$ in steps of $10\ \Omega$. (Refer 6.4 Menu Beep level setting). Ohm Continuity will be heard, $\pm 5\ \Omega$ of set value.

(Refer Technical Data for detailed accuracy and other specifications)

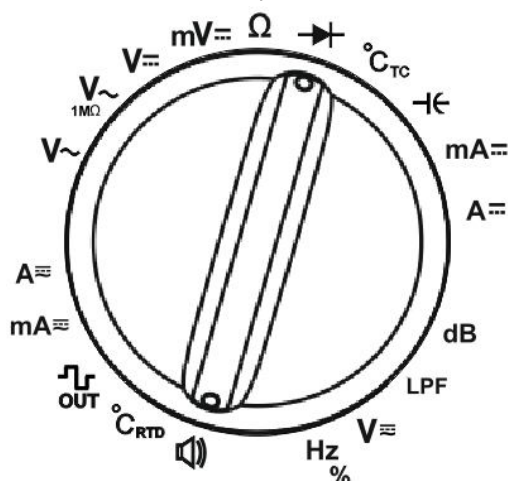
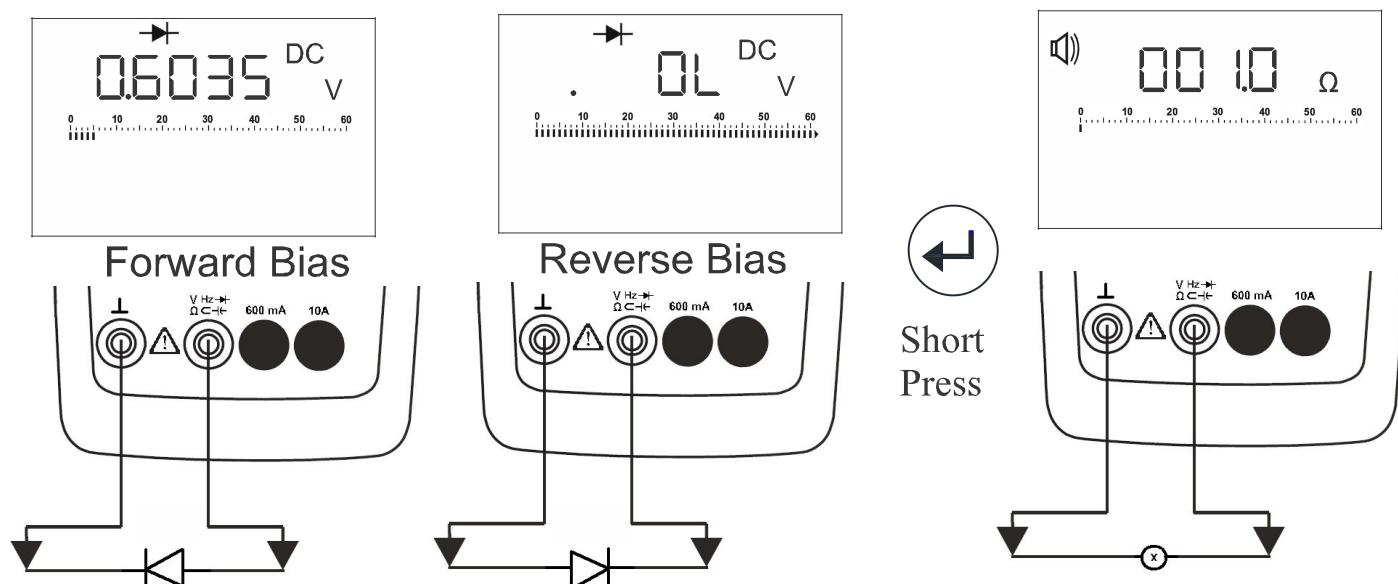

Fig: Select diode function for continuity or diode test



Making Measurements

5.5 Temperature Measurement

DMM 601X series facilitates temperature measurements from sensors like thermocouple TYP-K, TYP-J, PT100 and Pt1000.

Thermocouple function:

- Keep the knob Temperature function, “K” symbol appears on the main display and make the connection to the accessible terminals of thermocouple as shown in the figure.
- “OL” is indicated on the display as an indication of open thermocouple junction.
- To select TYP J sensor press function key repeatedly until “J” appears on the main display.
- By default when meter starts internal compensation is selected for thermocouple, however external compensation can be selected from menu options. (*Refer 6. Menu for setting external reference temperature*).
- When on thermocouple functions, sub display indicates either ambient room temperature if internal reference is selected or the set reference temperature if external compensation is selected.

RTD (PT100/PT1000)function:

- Keep the knob on Temperature function, press function key repeatedly until “PT100” appears on the main display.
- To select “PT1000”, press function key repeatedly until PT1000 appears on main display.
- To subtract the lead resistance, keep the meter in ohm function initially and short the leads of the probe, note down the resistance value, set the same value as lead resistance in menu. Now switch to “PT1000” measuring function (*Refer 6. Menu for lead sensor setting*). The meter will indicate the temperature relative to the resistance at the terminal minus lead resistance.

(Refer Technical Data for detailed accuracy and other specifications)

Making Measurements

Short Pressing  will change the measuring unit for temperature

Deg Celsius



Deg Fahrenheit



Kelvin

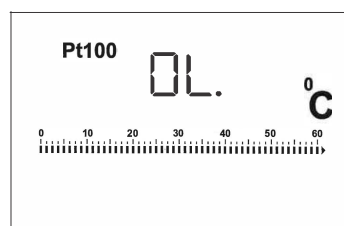
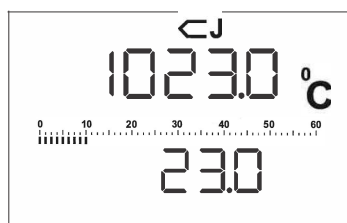
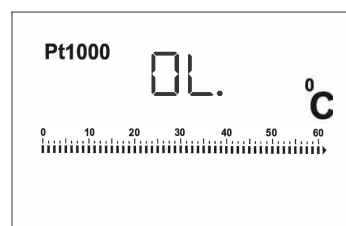
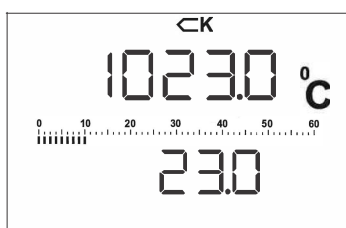
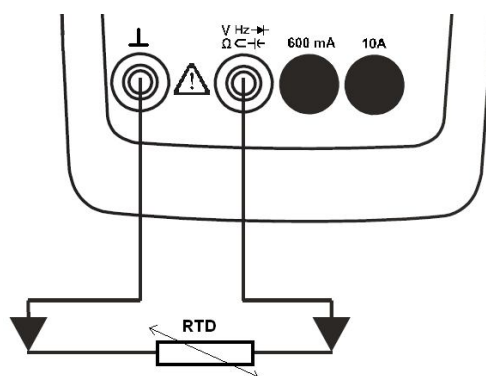
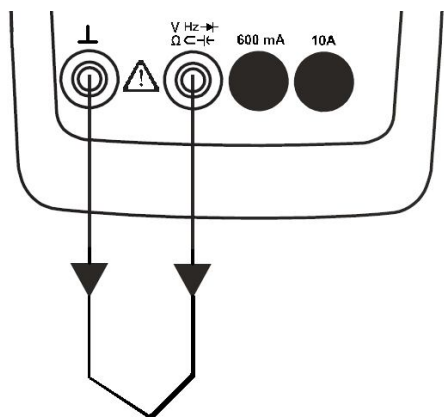
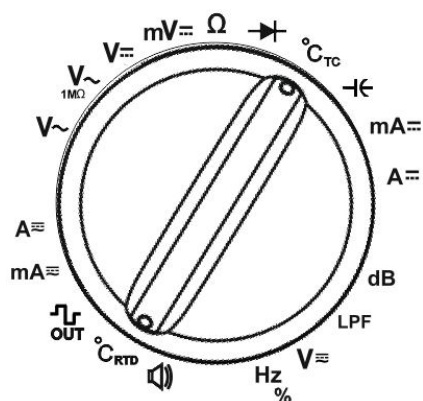

Making Measurements

5.6 Capacitance measurement

- Select the capacitance function using knob selector switch.
- Make sure the capacitance to be measured is electrically disconnected.
- Discharge the capacitance before measuring as the large reservoir capacitors can get charged up to several thousand volts.
- The set up for capacitance measurement is shown in the figure.

Notes

- For accuracy in capacitance range use zero balancing. (*Refer 4.4 REL/ZERO function*)

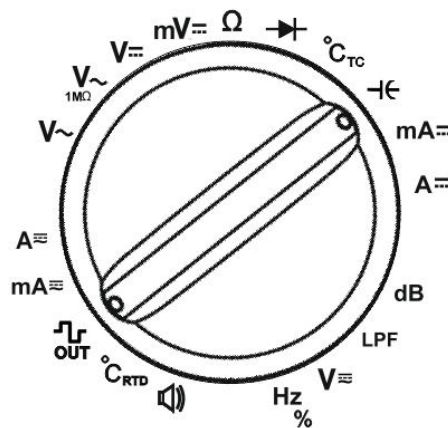
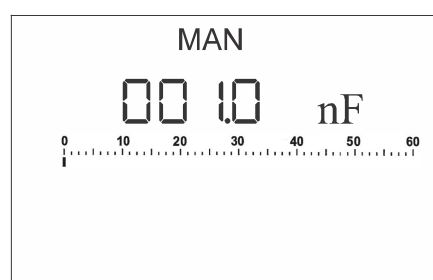
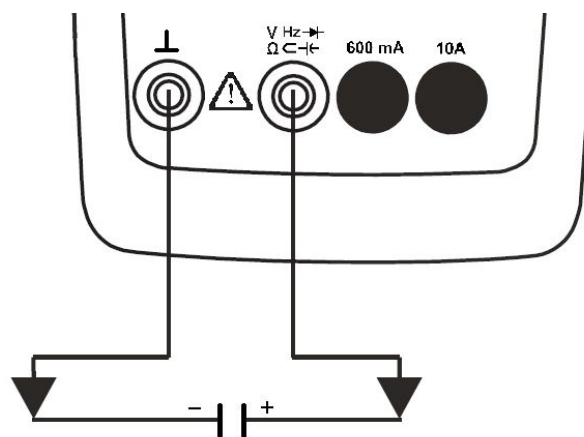

Fig: Select capacitance function using knob selector switch.



Making Measurements

5.7 Square wave out function

The square wave output function can be used to generate a Pulse output with programmable duty cycle or provide a synchronous clock source. You can also use this function to check and calibrate flow-meter displays, counters, tachometers, oscilloscopes, frequency converters, frequency transmitters, and other frequency input devices.

- To use square wave output function select the capacitance (C) function using knob selector switch, and briefly press the function key f_{t} symbol will appear on the main display.
- Frequency and duty cycle for square wave out function can be selected from **PULSE** menu.
- The default setting for square wave is 1KHZ and 50%.
(Refer Menu 6.3 for setting of square wave out)

Note

- There will be No datalogging available in square wave out function though REC symbol is shown on display.

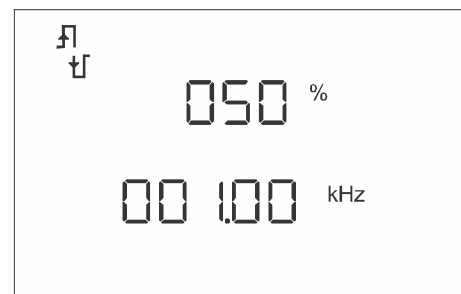
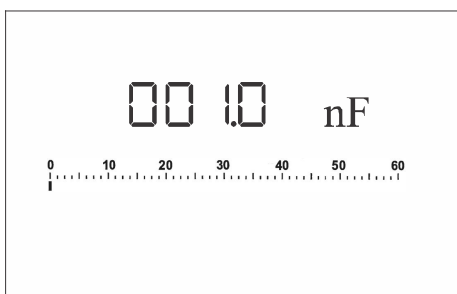
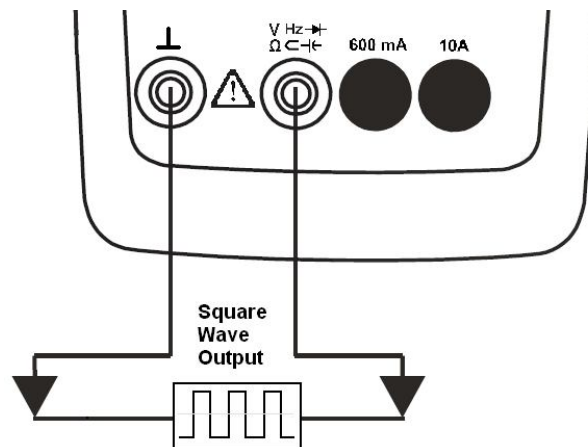

5.8 Current measurement (mA, A)

📝 Notes

- DMM 6012 contains a 1.6A fuse, where as DMM 6015 and DMM 6016 contains a 16A fuse, DMM 6013 is unfused, it is designed for measurements in current transformer circuits and is approved for measuring category 600 V CAT II.
- Use multimeter with the supplied fuse only, the fuse must have a breaking capacity of 30kA at least.
- To avoid fuse blow, ensure the input doesn't crosses the specified rating. (*Refer technical data for information about fuse.*)
- When doing current measurements with a blown fuse, "FUSE" is displayed on the meter as an indication to replace the fuse.
- **While replacing the fuse ensure the meter is not connected to any measuring circuit.** (*Refer 9.3.1 Replacement of fuse*)
- Be absolutely certain that the measuring ranges are not overloaded beyond their allowable capacities. (*Refer technical data for information about overload capacity of all measuring ranges.*)
- DMM 601X series supports different set able clamp ratio. (*Refer table for different ratio*). (*Refer 6. Menu for setting clamp ratio*).
- Clamp ratio will have its effect only in "ACDC" mode for both mA and Ampere functions.

Making Measurements

Table to indicate the scope of the function

Measuring Functions	6012	6013	6015	6016
mA DC & mA ACDC	600mA		•	•
mA AC			•	•
Clamp 1:1,1:10,1:100			•	•
Clamp 1:1000	600mA	6A	•	•
ADC & AACDC		6A/16A	•	•
A AC			•	•

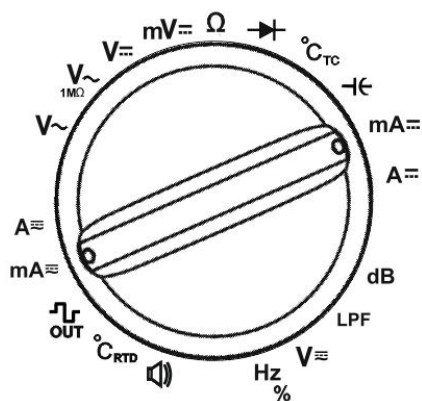

Fig: Select mA DC function using knob selector switch.

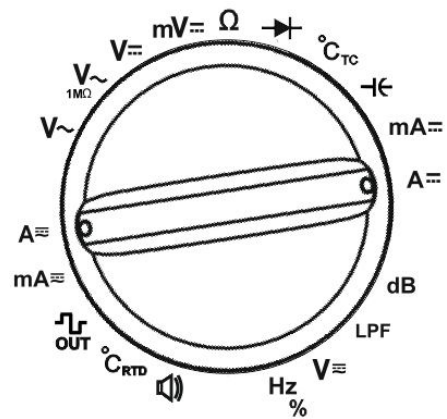

Fig: Select A DC function using knob selector switch

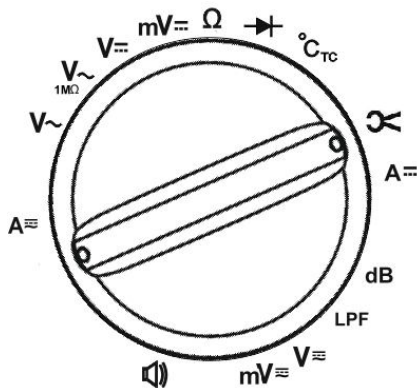

Fig: For 6013 Select ∞ function using knob selector switch.

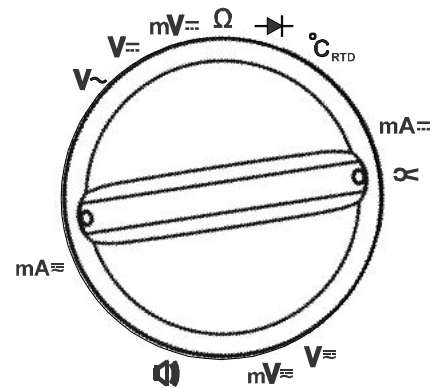
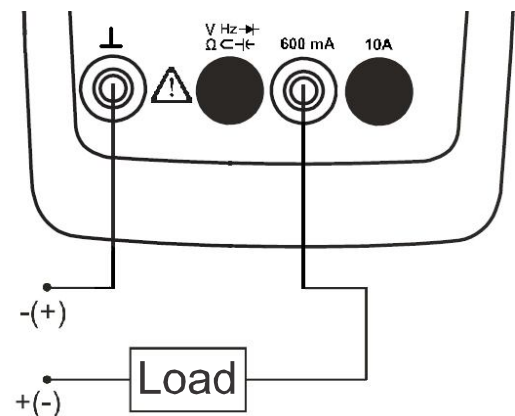
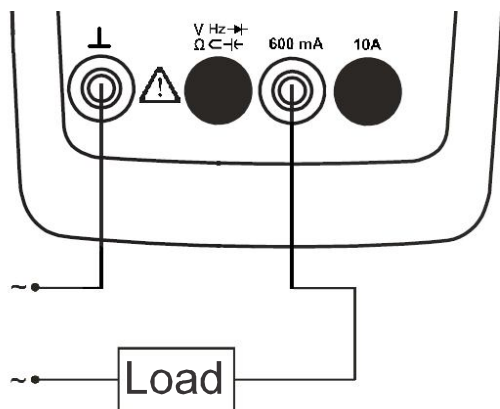

Fig: For 6012 Select ∞ function using knob selector switch

Making Measurements

5.8.1 mA (DC, AC or ACDC) measurements

- Disconnect all the supply from the circuit whose current is to be measured.
- To measure DC current turn the knob selector switch to position mADC. The “DC” symbol along with “mA” symbol will be displayed on the main display.
- To measure AC current, short press function key until only “AC” symbol will appear on the main display.
- To measure AC DC current, short press function key until “ACDC” symbol appears on the main display. (*Refer technical data for accuracy and other specifications*)
- In “ACDC” mode if clamp function is enabled, then a clamp symbol will also be indicated on main display. (*Refer 6. Menu for clamp setting to turn off the clamp ratio.*)
- In mADC mode if scale function (0-20 or 4-20 mA) is enabled then display will indicate input current in terms of %. (*Refer 6. Menu scale function setting.*)
- Long press function key to exit from mAAC or mAACDC function. On long press meter reconfigures it self back in mADC mode.



Making Measurements

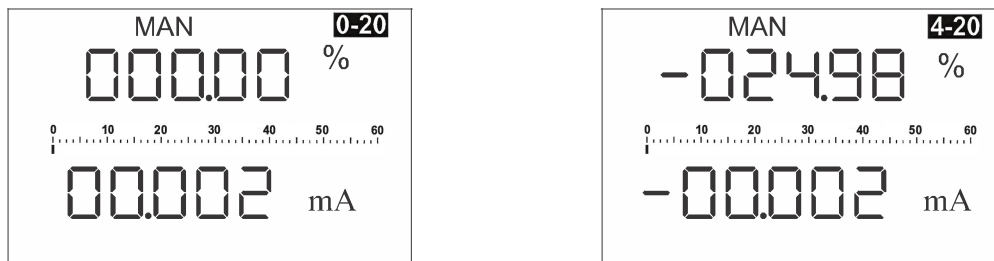
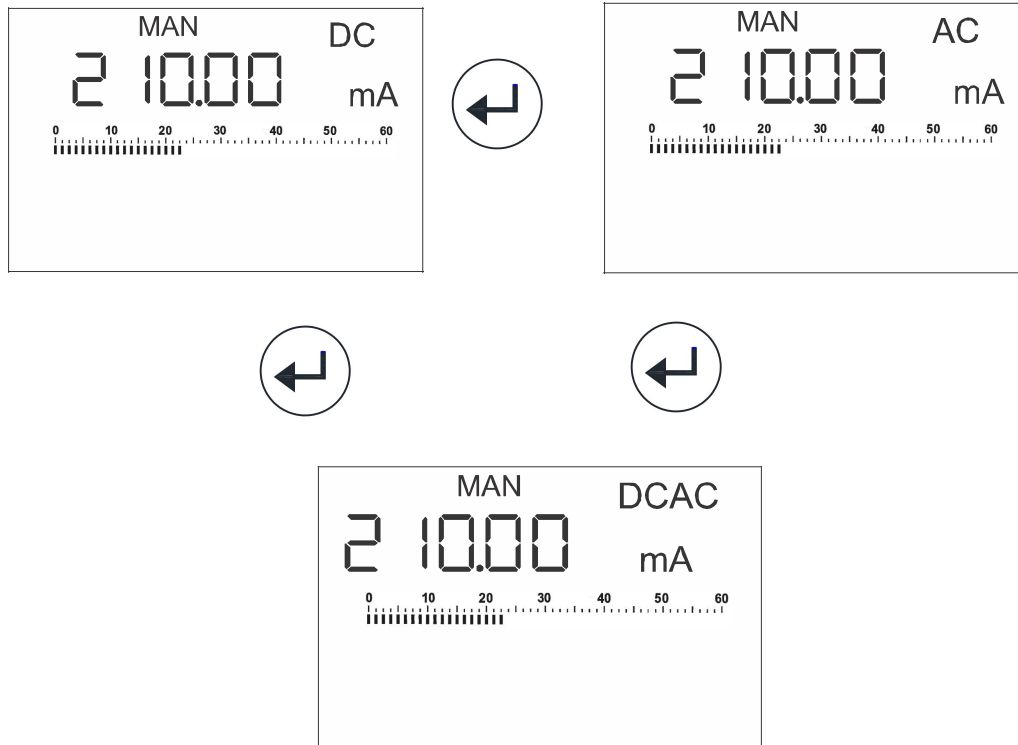

Screen: 0-20 or 4-20mA scale function.

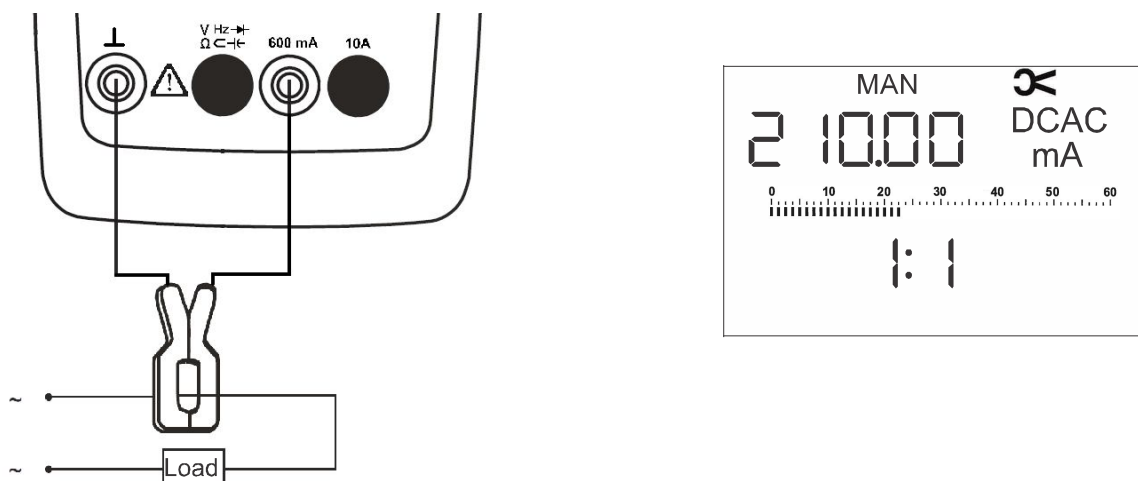
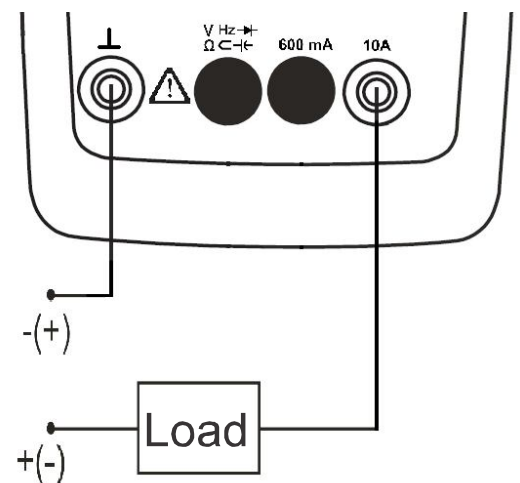
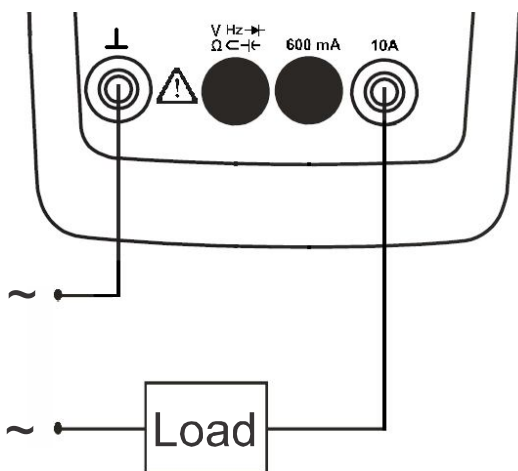

Fig: Setup for measurement using clamp function.

Making Measurements

5.8.2 A (DC, AC or ACDC) measurements

- Disconnect all the supply from the circuit whose current is to be measured.
- To measure DC current turn the knob selector switch to position **ADC**. The “**DC**” symbol along with “**A**” symbol will be displayed on the main display.
- To measure AC current, short press function key until only “**AC**” symbol will appear on the main display.
- To measure AC DC current, short press function key until “**ACDC**” symbol appears on the main display. (*Refer technical data for accuracy and other specifications*)
- In “**ACDC**” mode if clamp function is enabled, then a clamp symbol will also be indicated on main display. (*Refer 6. Menu for clamp setting to turn off the clamp ratio.*)
- Long press function key to exit from **AAC** or **AACDC** function. On long press meter reconfigures it self back in **ADC** mode.



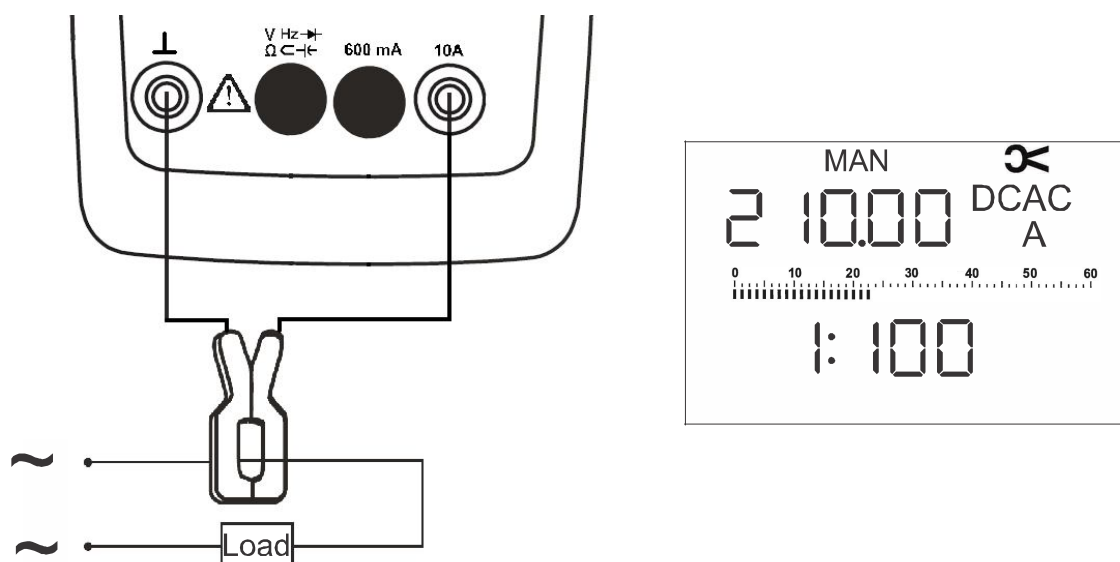
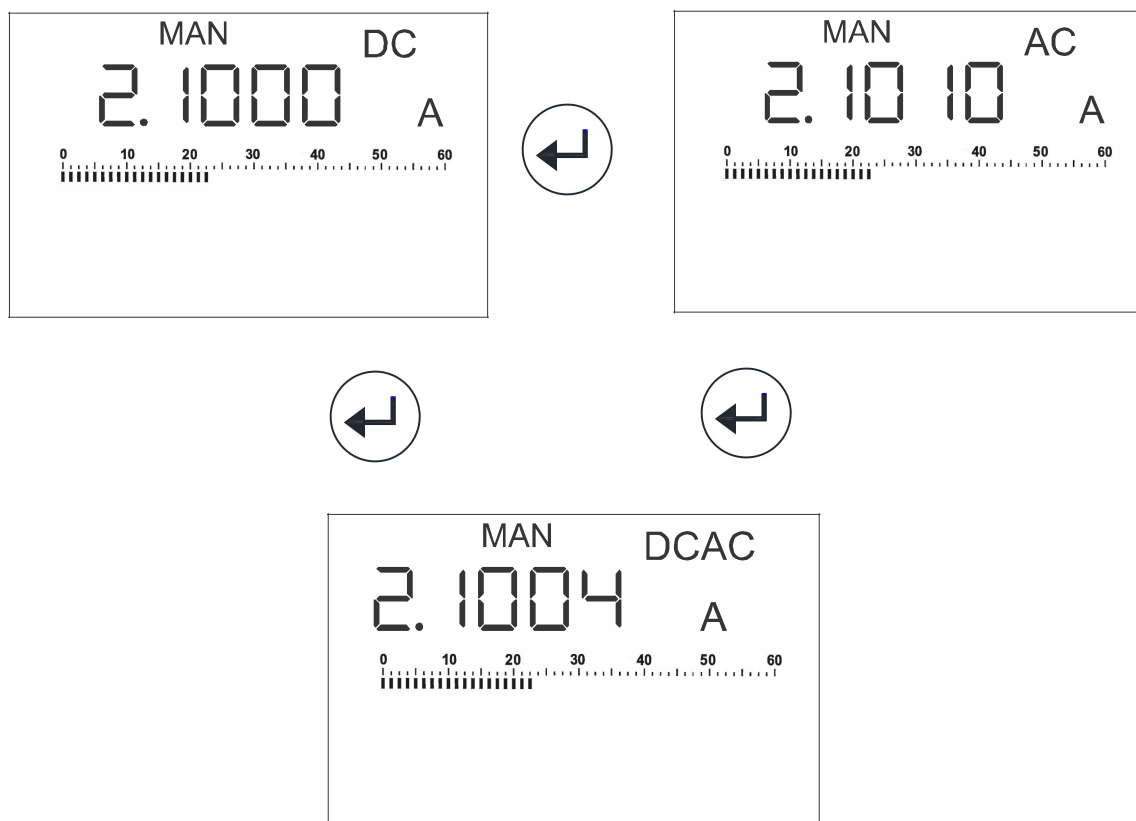
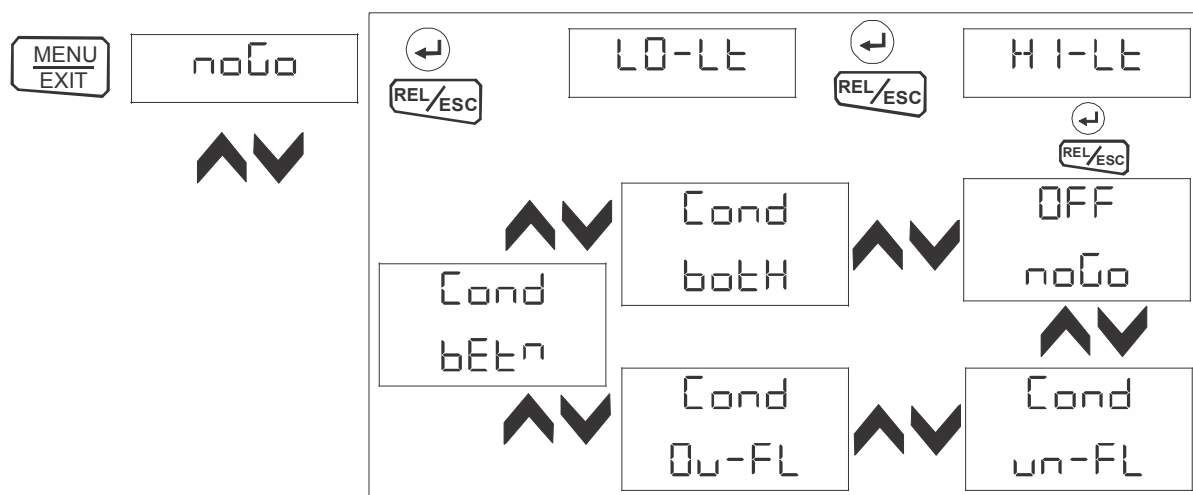
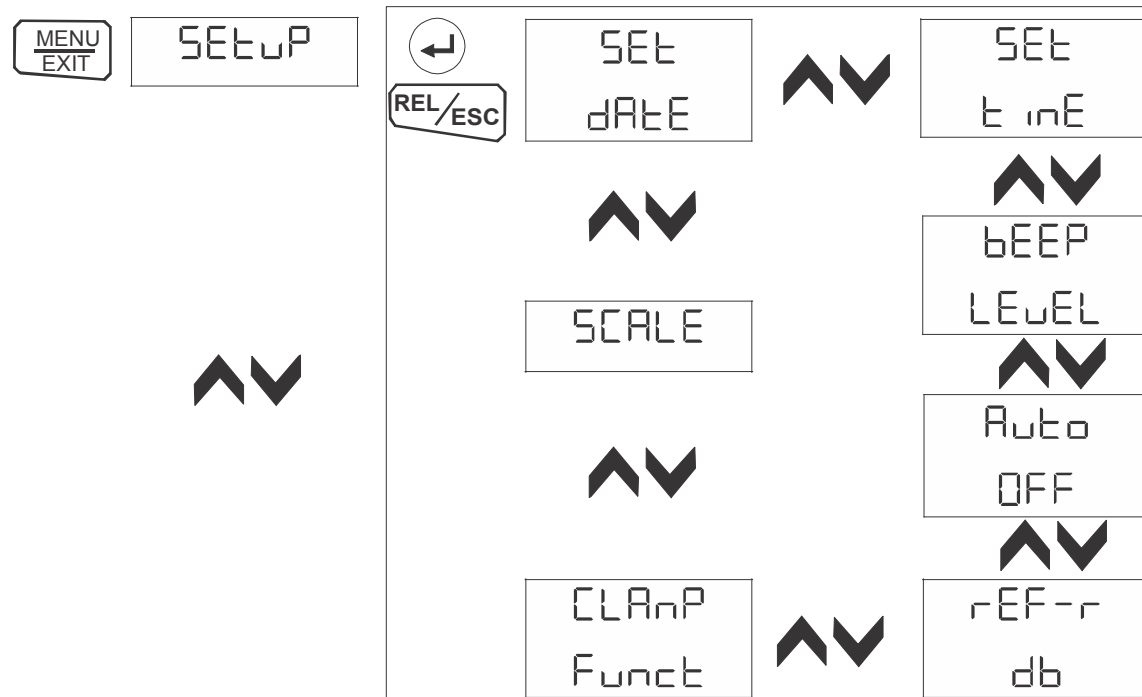
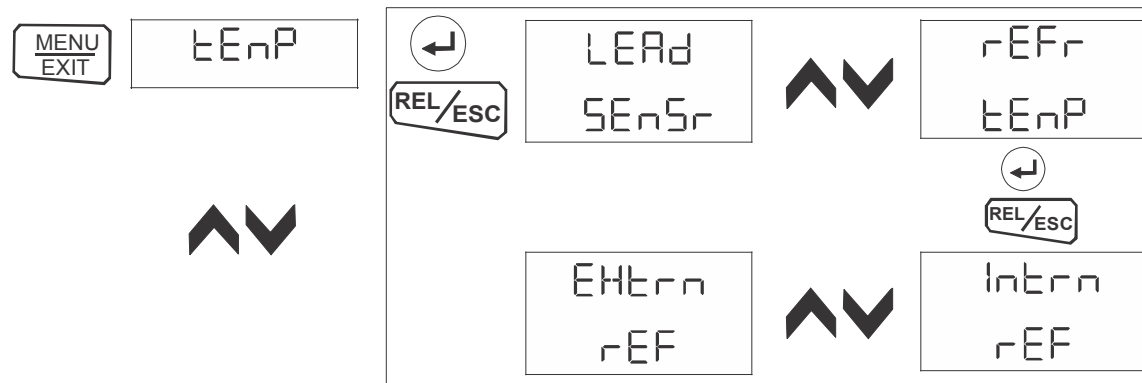
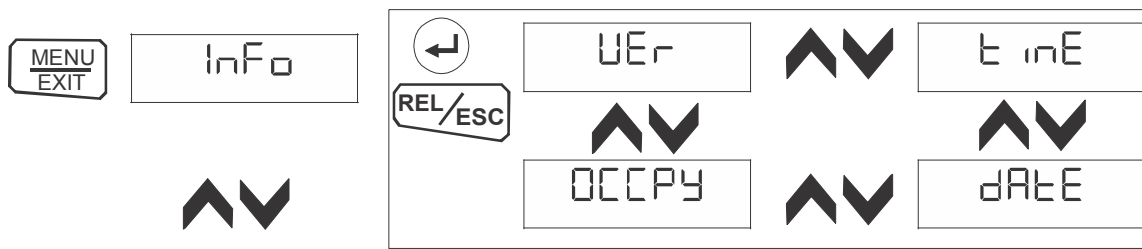
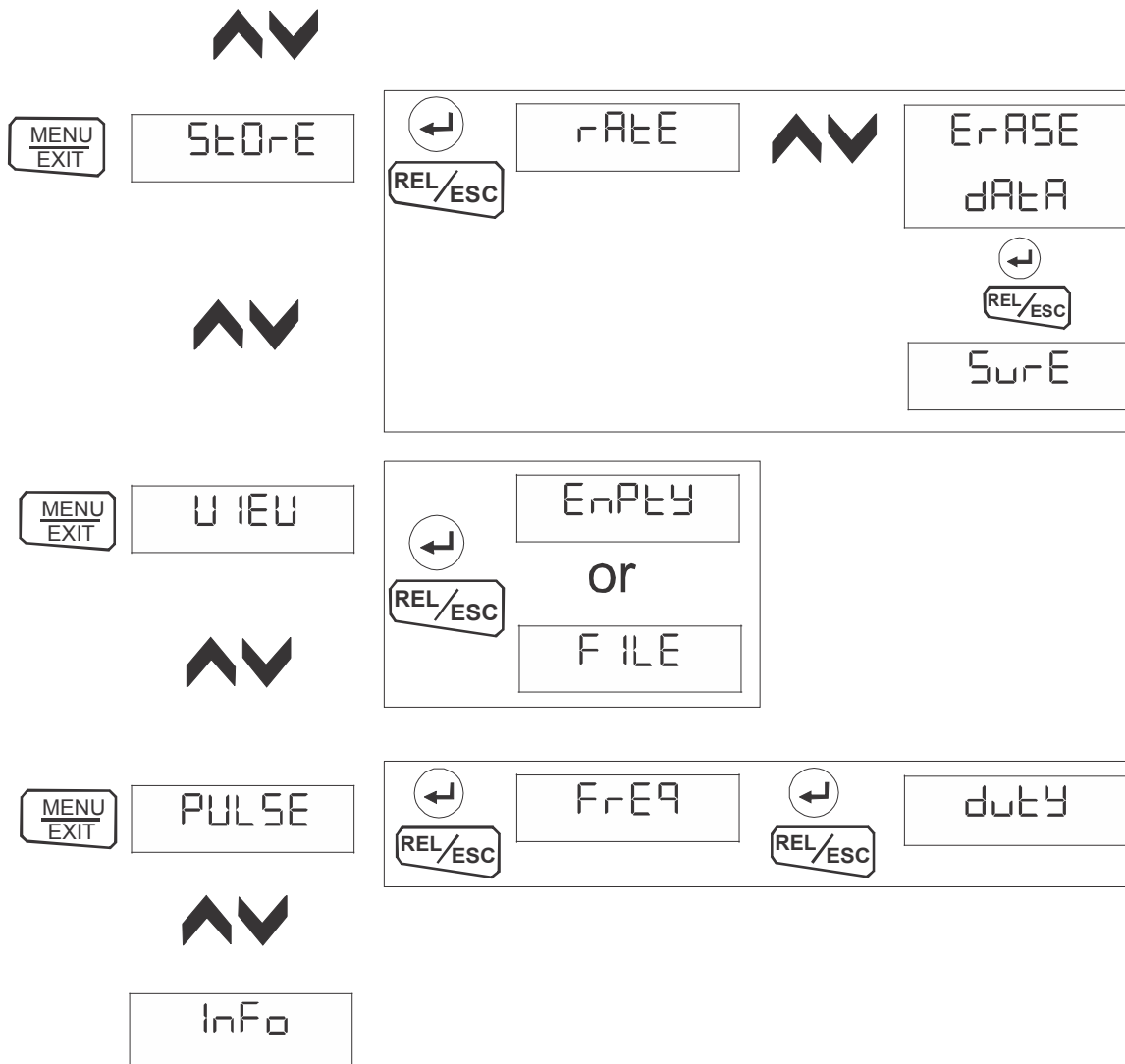

Fig: Setup for measuring current using clamp function

Menu

6. Menu





Path of Various Parameter

6.1 List of all Parameter

Symbol	Meaning
PULSE	Square Wave Output Setting Menu Screen
FREQ	Square Wave Output Frequency
DUTY	duty Cycle
-SEt-	Setting Configured Successfully
bAtt	Battery Voltage
tEnP	Temperature function menu screen

Menu

Symbol	Meaning
Info	Information menu screen
VER	Firmware Version
OCCPY	Memory Space Used in %
t inE	Meter Time
dAtE	Meter Date
tEnP	Temperature function menu screen
LEAd SENsr	Lead Resistance value for Pt100 & Pt1000
Ld-Sn	Lead Sensor / Resistance
rEFr tEnP	Reference Temperature for Thermocouple
IntErn rEF	Internal Reference Temperature for Thermocouple
EXtErn rEF	External Reference Temperature for Thermocouple
rEFr	Reference Temperature for External Reference Temperature
SEtUP	Configurable parameter setup menu
SEt dAtE	Set Internal Clock Date
dddMM.20yy	d. means date dd.MM. 20yy set date parameter
SEt t inE	Set Internal Clock Time
SCALE	Percentage Scale Function
OFF SCALE	No Percentage Scale Function
0-20 SCALE	0-20mA Percentage Scale Function
4-20 SCALE	4-20mA Percentage Scale Function
rEF-r db	Reference decibel resistance value
db	decibel
BEEP LEvEL	Continuity Threshold Value
AutOFF	Meter Power off setting
On	Continuous Meter on

Menu

Symbol	Meaning
CLAMP Funct	Standard Clamp Ratio Selection
SEL OFF	Clamp Ratio Conversion is off
SEL 1:1	Clamp Ratio Conversion is 1:1
SEL 1:10	Clamp Ratio Conversion is 1:10
SEL 1:100	Clamp Ratio Conversion is 1:100
SEL 1:1000	Clamp Ratio Conversion is 1:1000
LO-Lt	NoGo Lower Limit
HI-Lt	NoGo Higher Limit
OFF noGo	NoGo Disabled
Condun-FL	NoGo Condition: underflow
CondOu-FL	NoGo Condition: Overflow
CondbEt ⁿ	NoGo Condition: in-between
CondbOtH	NoGo Condition: both
StORe	Datalogging Menu Screen
rAtE	Time at which data to be logged
ERASE dAtA	Erase Complete logged data
SurE	Erase Confirmation
SAnPL	Sample Rate
U IEU	View logged Data Menu Screen
EnPtY	No Data Logged
F ILE	File Number of the Logged Data
db	decibel
StOP	Stop Datalogging
End	File Logged Data End
StARt	File Logged Data Start

6.2 Querying Parameter - Info Menu

- Press Menu/Exit Key to Enter in Menu Screen.



- Press Enter/Function key on

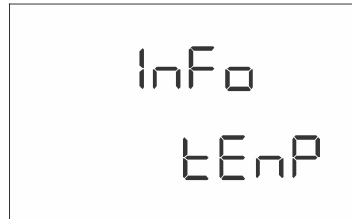

- Version Screen will be shown



- Press Up/down Key to access different information parameter



- Press REL/ESC key to go back to Info Screen.

6.3 Entering Parameter

The Parameter like Lead Sensor (Lead Resistance), External Reference temperature, date, time, beep level (Continuity Threshold), Auto Power OFF, Reference db, NoGo, rate, View, Pulse (Square Wave out), etc. are settable parameter where values (data) can be modified.

Example:

Suppose that we have to change external reference temperature for thermocouple.

Menu

- Press Menu/Exit Key to Enter in Menu Screen.



- Press Up/down key till you get following screen.



- Press Enter key.



- Press Up/Down key till you get following screen.

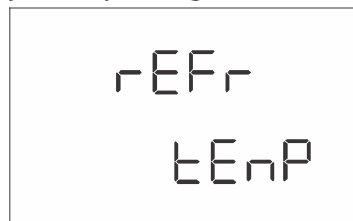

- Press Enter key.



- Press Up/Down key till you get following screen.



- Press Enter key.



- The blinking digit is editable.



- By pressing Left / Right key, the position of editable digit can be changed.
- By long pressing Left key, the minus sign can be visible.
- By Pressing Enter key will set the external Reference Temperature.
- Similarly, other parameter can be set.

6.4 Parameter

6.4.1 LEAD SENSOR (Lead Sensor)

The Lead Sensor resistance is probe resistance used during Pt100 & Pt1000 sensor measurement. The resistance can be from 0Ω to 99Ω . Default value is 0Ω .

6.4.2 BEEP LEVEL (Beep Level)

The Beep Level means continuity threshold value. The acoustic signal indication when its satisfy the continuity threshold condition. The Beep Level can be from 10Ω to 90Ω in step 10Ω . Default Value is 40Ω .

6.4.3 REF-db (Reference db)

The reference db is used to measure power in db while measuring the Voltage AC. The reference db resistance value is used in dbm measurement. The reference db can be from 1Ω to 9999Ω . Default value is 50Ω

6.4.4 CLAMP FUNCTION (Clamp Function)

The Clamp function is used to set standard clamp ratio like 1:1, 10:1, 100:1, 1000:1, etc to get its exact value on meter like 1:1, 1:10, 1:100, 1:1000, etc. Default condition is "OFF"

CLAMP SEL	Measuring Ranges DMM		
	60mA ACDC	600mA ACDC	6A ACDC
1:1	60mA	600mA	6A
1:10	600mA	6A	60A
1:100	6A	60A	600A
1:1000	60A	600A	6000A

6.4.5 SCALE (Scale)

The Scale function is used for conversion of mA in Percentage Scale. The range used in scale function is 60mA DC. There are two types of scale factor.

6.4.5.1 Scale Factor 0-20mA

The 0-20mA is converted into 0-100% respectively.

$$\% \text{ Scale} = \left(\frac{\text{Applied Input (mA)}}{20\text{mA}} \right) \times 100 \%$$

6.4.5.2 Scale Factor 4-20mA

The 4-20mA is converted into 0-100% respectively.

$$\% \text{ Scale} = \left(\frac{\text{Applied Input (mA)} - 4\text{mA}}{16\text{mA}} \right) \times 100 \%$$

6.4.5 NOGO (NoGo)

GO NO-GO feature for all measuring functions. This is very useful feature which gives acoustic signal, if the measured value is outside the NO-GO band or inside the NO-GO band or Below the limit or Above the limit. All conditions are settable. Limits or band for GO NO-GO are also settable. Its very useful feature to give pass or fail signal in case of measurement is not in the desired band.

6.4.5.1 NoGo Conditions

6.4.5.1.1 OFF NOGO (NoGo OFF)

If this condition is set, then NoGo Function is turned off.

6.4.5.1.2 Condboth (Condition Both)

When main display reading is lower than the *Lower Limit* or higher than the *Higher Limit* then meter gives acoustic signal.

6.4.5.1.3 CondOv-FL (Condition OverFlow)

When main display reading is higher than *higher Limit* then meter gives acoustic signal.

6.4.5.1.4 CondUn-FL (Condition UnderFlow)

When main display reading is lower than *Lower Limit* then meter gives acoustic signal.

6.4.5.1.5 CondBEtⁿ (Condition In-between)

When main display reading is higher than the *Lower Limit* and also lower than the *higher Limit* then meter gives acoustic signal.

Note: NoGo Limit: Higher Limit \geq Lower Limit.

Acoustic sound is heard when there is "OL" on display irrespective of NoGo setting

6.4.6 rALE (Datalogging time (rate))

Rate is the time interval at which data to be logged in memory (flash). After pressing Enter key on rate screen, first memory occupancy and then current file number will be shown and then it will ask for time interval for datalogging. The time interval can be set from 100msec to 59 min 59 sec 900msec. Default rate is 100msec.

The rate set in the format: Minute.Seconds.Hundredth of Milli-Seconds.

Min.Sec.100th of ms

00.00.1

SAMPLE

Eg:

- We have to set value 1min , 1sec and 500msec then the display will look like "01.01.5".
- We have to set value 900msec then the display will look like "00.00.9".

6.4.7 PULSE (Square Wave Out Menu)

The Pulse (Square wave out menu) is used to set frequency and duty cycle for square wave.

- After Pressing Enter key, on Pulse screen the following screen will be shown



The screenshot shows a digital display with the frequency set to 100 kHz. The text 'FREQ' is displayed below the frequency value. The frequency is shown as '00 100 k Hz' with a small 'f' and 'u' symbol above the first two digits.

- The Frequency can be set from 0.03kHz to 500.00kHz.
- Now, after pressing Enter key, following screen will be shown.

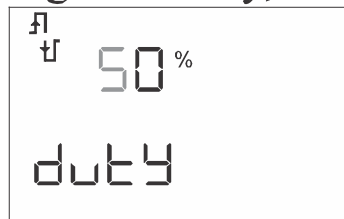

The screenshot shows a digital display with the duty cycle set to 50%. The text 'duty' is displayed below the duty cycle value. The duty cycle is shown as '50 %' with a small 'f' and 'u' symbol above the first two digits.

- The duty cycle can be set in step 10 from 10 % to 90%
- The blinking digit are editable digit. By using Left/Right key position of blinking digit can be changed.
- After Pressing Enter key, on duty cycle screen, it will shown -SET-
- To see the result, goto knob position capacitance and pressing function key (Yellow key). The following will be shown. The Square wave of $\pm 3V$ for setted frequency and duty cycle will result in, on terminal.

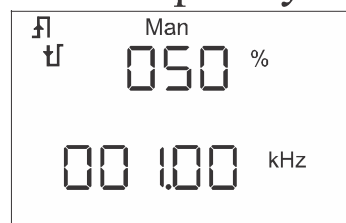

The screenshot shows a digital display with the frequency set to 100 kHz and the duty cycle set to 50%. The text 'Man' is displayed above the duty cycle value. The frequency is shown as '00 100 kHz' with a small 'f' and 'u' symbol above the first two digits. The duty cycle is shown as '050 %' with a small 'f' and 'u' symbol above the first two digits.

6.4.8 VIEW (View Function)

The view function is for viewing logged data in the memory. When a file number is entered in file number menu the logged reading of that file is shown on screen. The **START** will be shown if viewing counter reaches bottom of file. The **END** will be shown if viewing counter reaches top of file.

Note

- When we are in view function, then No data will be sent to PC
- When recording is ON, we cannot view previously logged data

Technical Data

7. Technical Data

7.1 Voltage

Measurement Function	Measuring Range	Resolution	Input Impedance	Intrinsic Uncertainty under Reference Condition $\pm(\dots\%$ of the rdg.+...Digits)			Overload Capacity ²⁾	
				DC ⁷⁾	AC ^{1) 3)}	ACDC ^{1) 3)}	Value	Time
V	6V	100 μ V	>9M Ω	0.05 + 5	0.5 + 9	1 + 30	1000 V DC/ AC RMS	Continuous
	60V	1mV		0.05 + 5				
	600V	10mV		0.05 + 9				
	1000V	100mV		0.09 + 10				
mV	60mV	1 μ V	>10G Ω	0.09 + 15	-	1 + 30	Sine	Max 10 s
	600mV	10 μ V		0.09 + 15				

Influence Quantity	Range of Influence	Range	Accuracy	
			DMM 6016	Others ⁴⁾
Frequency ⁶⁾⁹⁾	>15 Hz....45 Hz	60 mV ~ ⁵⁾ , 600	3+30	
	>65 Hz....100kHz		3+30	
	>15 Hz....45 Hz	6V, 60V, 600V ~	2+9	3+9
	> 65Hz... 1kHz		1+9	3+9
	>1kHz.....20kHz		3+9	4+9 ¹⁰⁾
	>20kHz....100kHz ⁸⁾		3.5+30	
	>15 Hz....45 Hz	1000V ~	2+9	3+9
	> 65Hz... 1kHz		2+9	3+9
>1kHz.....10kHz	3+30			

1) Specified Accuracy is valid as of 3% of the measuring range. With Short-circuited test probes: residual value of 1 to 30 d at zero point due to the TRMS converter.

2) At 0°C to 40°C (Accuracy Range)

3) In VAC measurement, Frequency will be shown above 10% of the present range, except for 1000V & 60mV range i.e. 25% & 50% respectively.

4) Frequency Influence upto 10kHz.

5) Frequency response up to 50 kHz

6) Frequency response is valid from 10% to 100% of range

7) With Zero Balancing

8) Frequency response up to 100 kHz, for greater than 50 kHz plus 2.5%

9) Overload capacity of the voltage measurement input: power Limiting: Frequency x Voltage Max : 6×10^6 V x Hz

10) Frequency response greater than 2 kHz plus 2.5%

7.2 Reference Condition for Accuracy

Reference Temperature	23°C \pm 1K
Relative Humidity	45%...55% RH
Waveform of measured quantity	Sinusoidal
Input frequency	45 or 65 Hz
Battery Voltage	3 V \pm 0.1 V

Technical Data

7.3 Frequency, Duty Cycle

Measurement Function	Measuring Range	Frequency	Intrinsic Uncertainty	Overload Capacity ¹⁾	
				Value	Time
Hz ⁵⁾	600Hz, 6KHz, 60KHz, 600KHz, 1MHz	fmin ²⁾ : 6Hz	0.05 + 5	1000 V DC/ AC RMS Sine	Max 10 s
Hz(V) ³⁾	10Hz.....100KHz		0.1 + 5 ⁴⁾		
Duty Cycle(%)	2.0...98%	15Hz ... 1kHz	0.1 R + 5 d		
	5.0...98%	... 10kHz	0.2 R per kHz + 5d		
	10...90%	... 50kHz	0.5 R per kHz + 5d		

1) At 0°C to 40°C (Accuracy Range)

2) Lowest measurable frequency for square measuring signals symmetrical to the zero point ($\pm 5V$).

3) Overload capacity of the voltage measurement input :

Power limiting: Frequency x voltage max : $6 \times 10^6 V \times Hz$ for $U > 100V$.

4) Input sensitivity, sinusoidal signal , 10% to 100% of the measuring range

5) At input $\pm 5V_{rms}$,Square wave, Bipolar inputs.

R= Range d= digit

7.4 Ampere

Measurement Function	Measuring Range	Resolution	Voltage Drop Approx.	Intrinsic Uncertainty under Reference Condition $\pm(\dots\%$ of the rdg. + \dots Digits)			Overload Capacity ²⁾	
				DC ⁴⁾	AC ¹⁾	ACDC ¹⁾	Value	Time
mA	600 μA	10 nA	60 mV	0.5 + 15	1 + 10	1.5 + 10	0.7A	Continuous
	6 mA	100 nA	60 mV	0.5 + 5	1 + 10	1.5 + 10		
	60 mA	1 μA	60 mV	0.1 + 5	1 + 10	1.5 + 10		
	600 mA	10 μA	60 mV	0.2 + 5	1 + 10	1.5 + 10		
A	6 A	100 μA	60 mV	0.9 + 10	1 + 10	1.5 + 10	10 A: = 5 min ³⁾	
	10 A	1 mA	300 mV	0.9 + 10	1 + 10	1.5 + 10		

Influence Quantity	Range of Influence	Range	Accuracy	
			DMM 6016	Others
Frequency ⁵⁾	> 15 Hz.....45 Hz	600 μA	3+10	
	>65Hz.....10 kHz	10A		

1) Specified Accuracy is valid as of 3% of the measuring range. With Short- circuited test probes: residual value of 1 to 30 d at zero point due to the TRMS converter.

2) At 0°C to 40°C (Accuracy Range)

3) Off time 30 min and $T_A = 40^\circ C$

4) With Zero Balancing

5) Frequency response is valid from 10% to 100% of range

Technical Data

7.5 Resistance, Diode, Continuity

Measurement Function	Measuring Range ⁴⁾	Resolution	Open Ckt. Voltage	Intrinsic Uncertainty	Overload Capacity	
					Value	Time
Ω ¹⁾	600 Ω	10m Ω	<1.4V	0.1 + 10	1000 V DC/ AC RMS Sine	Max 10 s
	6k Ω	100m Ω		0.1 + 10		
	60k Ω	1 Ω		0.1 + 10		
	600k Ω	10 Ω		0.5 + 10		
	6M Ω	100 Ω		1 + 10		
	60M Ω	10k Ω		5 + 10		
Continuity	600 Ω	-	Appx. 8V	3 + 5		
Diode ¹⁾	6.0V ³⁾	-	Appx. 8V	0.5 + 5		

1) Measurement of Resistance, Diode will be more accurate after removal from device under test

2) At 0°C to 40°C (Accuracy Range)

3) Displays up to max 6.0 V, "OL" in excess of 6.0V.

4) With Zero Balancing

7.6 Temperature

Measurement Function	Measuring Range		Intrinsic Uncertainty	Overload Capacity ¹⁾	
				Value	Time
Temperature °C/°F	Pt 100	-200 °C .. +850 °C	0.3 + 15 ²⁾	1000 V DC/ AC RMS Sine	Max 10s
	Pt 1000	-150 °C .. +850 °C	0.3 + 15 ²⁾		
	TC K	-200 °C .. +1372 °C	1% +20 ²⁾		
	TC J	-210 °C .. +1200 °C	1% +20 ²⁾		

1) At 0°C to 40°C (Accuracy Range)

2) Plus Sensor Deviation

Technical Data

7.7 Capacitance

Measurement Function	Measuring Range	Resolution	V _o MAX	Intrinsic Uncertainty	Overload Capacity ²⁾	
					Value	Time
F ³⁾⁴⁾	10 nF	10 pF	0.7 V	1 + 10 ²⁾	1000V DC / AC RMS Sine	Max 10 s
	100 nF	100 pF		1 + 6 ²⁾		
	1 μF	1 nF		1 + 6 ²⁾		
	10 μF	10 nF		1 + 6 ²⁾		
	100 μF	100 nF		5 + 6 ²⁾		
	1000 μF	1 μF		5 + 6 ²⁾		

1) At 0 °C to 40 °C (Accuracy Range)

2) Applies to measurements at film capacitors and battery operated.

3) Measurement of Capacitance will be more accurate after removal from device under test

4) With Zero Balancing

7.8 Influence Error

Influence Quantity	Range of Influence	Measured Quantity / Measuring Range ¹⁾	Variation ± (...% of rdg. + ...digits)/10K
Temperature	-10 °C to 21 °C & +25 °C to 50 °C	V DC	0.2 + 20
		V ~, VACDC	0.4 + 10
		600Ω to 600 kΩ	0.5 + 10
		> 600 kΩ	1.5 + 10
		mA / ADC	0.6 + 10
		mA / AAC, ACDC	0.8 + 10
		10nF...10μF	1 + 5
		100μF...1000μF	1.5+10
		Hz, Duty Cycle	0.2 + 10
		°C/°F pt100/pt100	0.5 + 10
		°C/°F thermocouple K/J	0.2 + 10
Relative humidity	75% 3 Days Meter off	V~, VDC, AAC+DC, A DC, F, Hz, °C, %, Ω	1 × intrinsic error

1) With Zero Balancing

7.9 Square Wave Output

Output	Range	Accuracy
Frequency	30Hz - 10kHz	0.1% x output frequency + 2 counts of DMM display
Duty Cycle	10% - 90% ^[2]	0.2% of Full scale ^[1]
Amplitude	Fixed -3.15 to 3.15V	±0.4V

1) For signal greater than 1kHz, add 0.2% per kHz to the accuracy

2) In Multiple of 10

Technical Data

7.10 Influence Quantity

Influence Quantity	Range of Influence	Measuring Ranges	Attenuation
Common Mode interference voltage	Noise quantity max. 1000 V dc	V dc	> 120 dB
	Noise quantity max. 1000 V ~ 50-60 HZ sinusoidal	6.0 V~,60 V~	>80 dB
		600 V~	> 70 dB
		1000 V~	> 60 dB
Normal Mode interference ratio	Noise quantity V ~ Value of the measuring range at a time Max. 1000V~,50Hz, 60Hz Sinusoidal	V dc	> 50dB
	Noise quantity max. 1000 V dc	V~	>110dB

7.11 Applicable Regulations & Standards

EMC Immunity	IEC 61326-1:2012, Table A.1
Immunity	IEC 61000-4-2 : 8 KV atmosphere discharge, 4 KV contact discharge
	IEC 61000-4-3 : 3 V/m
Safety	IEC 61010-1-2010
IP for water & dust	IEC 60529
Pollution degree	2
Installation category	1000 V CATIII / 600 V CATIV, 600V CATII for DMM 6013
High Voltage Test	7.4 kV (IEC 61010-1-2010), 3.5kV For DMM 6013
Test & Procedure	IS 13875

7.12 Environmental Conditions

Operating Temperature	-10 to +50 °C
Storage Temperature	-20 to +70 °C
Relative Humidity	<75% non condensing
IP	IP 50 for Housing, IP 20 for Terminal
Altitude	Up to 2000m

Technical Data

7.13 Crest Factor

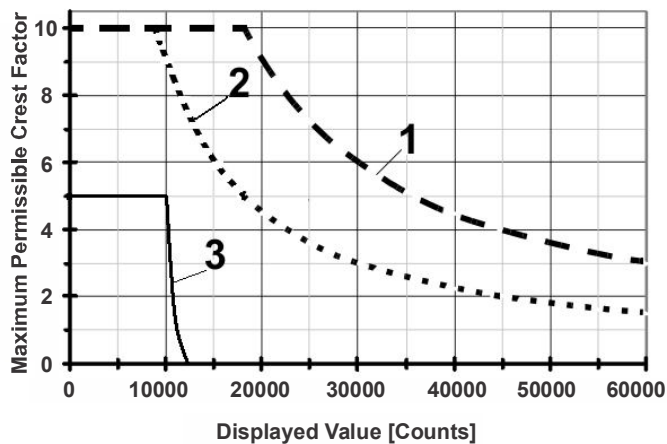

Additional Error Caused by Signal's
C.F : $1 < CF < 3$: (1% R + 30D)
 $3 < CF < 10$: (3% R)

Curve 1: Range from 0.06V to 60V,
0.6mA to 60mA, 6A

Curve 2: Range 600V, 600mA

Curve 3: Range 1000V, 10A

Note: With Unknown Waveform ($CF > 2$) measurement should be made with manual range selection.
R = Readings D = Digit

7.14 Internal Clock

Time Format	dd.MM.yy hh.mm.ss
Resolution	1 s
Accuracy	± 1 min. per month
Temperature Influence	50 ppm/K

7.15 Mechanical Design

Housing	PC ABS
Dimension	200 x 91 x 54 mm
Weight	Approx. 0.5 kg with batteries

Interface Option

8. Interface Option

The multimeters are equipped with an infrared interface for the transmission of measurement data to a PC. Measured data are optically transferred through the instrument housing by means of infrared light to an interface adapter (optional accessory), which is attached to the multimeter. The adapter's USB interface allows for the establishment of a connection to the PC via an interface cable. Beyond this, commands and parameters can be transmitted from the PC to the multimeter as well. The following functions can be executed:

- Multimeter Parameter Read and Configure
- Read Stored Values
- Data-logging of on- going function, range

8.1 Communication

Meter is automatically set for receive and send data. Communication is always initiated by PC (software).



Maintenance

9. Maintenance

Cautions

- Disconnect the instrument from the measuring circuit before opening the battery compartment lid or fuse cover in order to replace batteries or fuses!

9.1 Display - Error Message

Message	Function	Meaning
FUSE	Current Measurement	Fuse Blown
	In all operating mode	Low Battery Indication ($<2.4V \pm 0.2$)

9.2 Battery

The current battery charge level can be queried by long pressing ($>1s$) left arrow key ().



Make sure that no battery leakage has occurred before initial start-up, as well as after long periods of storage. Continue to inspect the batteries for leakage at short, regular intervals. If battery leakage has occurred, carefully and completely clean the electrolyte from the instrument with a damp cloth, and replace the batteries before using the instrument.

Note

- Battery Level should be queried when no input is applied to the terminal or when terminal leads are disconnected, to get correct battery readings. It is recommended to measure battery voltage, when knob is at voltage position.
- Battery voltage cannot be seen when NOGO or REL function is ON

Maintenance

If the “” symbol appears at the display, the batteries should be replaced as soon as possible. You can continue working with the instrument, but reduced measuring accuracy may result. The instrument requires two 1.5 V batteries in accordance with IEC R 6 or IEC LR 6.

9.2.1 Replacing the Batteries

Caution

Disconnect the instrument from the measuring circuit before opening the battery compartment lid in order to replace the batteries.

1. Set the instrument face down onto the working surface.
2. Turn the slotted screw on the lid with the battery symbols counter clockwise.
3. Lift off the lid and remove the batteries from the battery compartment.
4. Insert two new 1.5 V LR6 batteries into the battery compartment, making sure that the plus and minus poles match up with the provided polarity symbols.
5. When replacing the battery compartment lid, insert the side with the guide hooks first. Tighten the screw by turning it clockwise.
6. Please dispose of depleted batteries in accordance with environmental protection regulations

9.3 Fuse

It is recommended that you check the fuses of the multimeter before using it. If the fuse is blown, “**FUSE**” appears at the digital display. The fuse interrupts the current measuring ranges. All other measuring ranges remain functional.

Recommended Fuse:

Fuse	FF (UR) 16 A/ 1000 V AC/DC; 10 mm x 38 mm (DMM 6015 & DMM 6016)
	FF (UR) 1.6 A/ 1000 V AC/DC ; 6.3 mm x 32 mm (DMM 6012)
Switching Capacity	30 kA at 1000 V AC/DC (DMM 6015 & DMM 6016)
	10 kA at 1000 V AC/DC (DMM 6012)

9.3.1 Replacing the Fuse

Caution

Disconnect the instrument from the measuring circuit before opening the fuse compartment lid in order to replace the fuse.

1. Set the instrument face down onto the working surface.
2. Turn the slotted screw on the cover with the fuse symbol counterclockwise.
3. Lift off the cover and pry the fuse out using the flat side of the fuse cover.
4. Insert a new fuse. Make sure that the fuse is centered, i.e. between the tabs at the sides.
5. When replacing the fuse cover, insert the side with the guide hooks first. Tighten the screw by turning it clockwise.
6. Dispose of the blown fuse with the trash.

9.4 Case

Dirt or moisture in the terminals can distort readings. The steps for cleaning are as follows:

1. Turn the meter off and remove the test leads.
2. Turn the meter over and shake out any dirt that may have accumulated in the terminals.
3. Soak a clean swab with mild detergent and water. Work the swab around in each terminal. Dry each terminal using canned air to force the water and detergent out of the terminals.

10. Accessories

10.1 General Information

The extensive accessories available for our measuring instruments are checked for compliance with currently valid safety regulations at regular intervals, and are expanded as required for new applications.

10.2 DC Jack Power Supply

Use only the power pack provided with multimeter in combination with your instrument. This assures operator safety by means of an extremely well insulated cable, and safe electrical solution (nominal secondary ratings: 5 V / 1 A). Installed batteries are disconnected electronically if the power pack is used, and need not be removed from the instrument.

10.3 IR to USB

The IR (Infrared) to USB (USB 2.0) adapter make it possible to connect multimeter to PC. Adapter allows data transmission between the multimeter and the PC.

10.3.1 Rishabh Datalogger

Rishabh Datalogger is a measurement data logging program for recording, visualizing, evaluating and documenting measured values with reference to time for Model 6012, Model 6013, Model 6015 & Model 6016. It can also be used to configure the parameters of multimeter.

10.3.1.1 Online Datalog

The Current processed reading can be send directly to PC (software)

10.3.1.2 Offline Datalog

The Memory Stored data can be transferred to PC for evaluation of the data. During transfer of the memory data to PC meter shows:

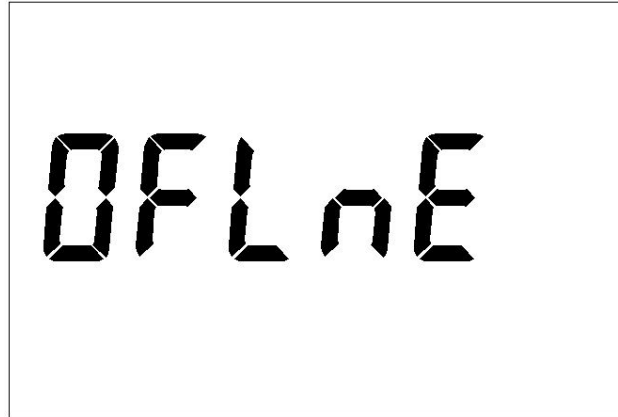

Note: *Do not read data from memory when battery is low.*

10.3.1.3 System Requirement

- Pentium IV & Higher Processor
- 2 GB RAM
- 50MB Hard drive space
- CD-ROM Drive
- Window XP Sp2, Window XP Sp3, Window Vista, Window 7
- Available USB Port (USB2.0)
- 800 x 600 or Higher Monitor Resolution

Warranty Card

Dear Customer,

You are now the privileged owner of Digital Multi-meter / Accessories, a product that ranks the first of its kind in the world.

Company provides 36 months warranty from the original date of purchase against defective material and workmanship.

In the unlikely event of failure of this meter / accessories within the warranty period, Company will repair the meter / accessories free of charges. Please hand over the meter / accessories to the dealer / Stockiest from whom you have purchased along with this card and relevant cash memo / Invoice. This warranty entitles you to bring the meter / accessories at your cost to the nearest stockiest / dealer and collect it after repairs.

NO TRANSPORTATION CHARGES WILL BE REIMBURSED

The warranty is not valid in following cases:

- 1) Warranty card duly signed / stamped and original cash memo / invoice are not sent along with the meter / accessories.
- 2) Complete warranty card is not presented to authorized person at the time of repairs.
- 3) Meter / accessories not used as per the instruction in the user manual.
- 4) Defect caused by misuse, negligence, accidents, tampering and acts of god.
- 5) Improper repairing by any person not authorized by the company.
- 6) Any sort of modification, alteration is made in electrical circuitry.
- 7) Seal provided inside is broken.

Warranty of Digital Multi-meter / Accessories does not cover fuses and battery. In case of dispute to the validity of warranty, the decision of Company's service center will be final.

If you bought this meter / accessories directly from the company, and if you notice transit Damage, then you must obtain the insurance surveyors report and forward it to Company.

Thank you.

(To be filled by authorized dealer)

Model No. : _____
Serial Number : _____
Date of Purchase : _____
Cash Memo / Invoice No. : _____
Dealer's Signature : _____
Dealer's Stamp : _____

Scope of Supply:

- | | |
|------------------------------|---------------------|
| 1) Meter | 2) Cable set |
| 3) Battery | 4) User Manual |
| 5) Protective Case (Holster) | 6) Test Certificate |
| 7) USB Interface adapter* | 8) DC Power Supply* |
| 9) Software CD* | |

* Optional or Only if ordered



RISHABH INSTRUMENTS PVT. LTD.

Factory: F-31, MIDC, Satpur, Nashik - 422 007 India

Phone: (0253) 2202202, 22020162

Fax: 91 - 0253 - 2351064, 2202302

Email: International: exp.marketing@rishabh.co.in

India: marketing@rishabh.co.in

Web: www.rishabh.co.in

Printed in India, Subject to change without Notice