

# Operating Manual

## *RISH Master 3430i*





# INDEX

## Touch Screen Digital Multi-function Meter Installation & Operating Instructions

### Section Contents

1. Introduction
2. Measurement Reading Screens
3. Programming
  - 3.1 Password Protection
    - 3.1.1 Change Password
  - 3.2 Menu selection
    - 3.2.1 System Parameter selection screen
      - 3.2.1.1 System type
      - 3.2.1.2 Potential transformer Primary value
      - 3.2.1.3 Potential transformer Secondary value
      - 3.2.1.4 Current transformer Primary value
      - 3.2.1.5 Current transformer Secondary value
      - 3.2.1.6 Auto Scrolling
      - 3.2.1.7 Low current noise cutoff
      - 3.2.1.8 Energy On Resolution
      - 3.2.1.9 Energy digit reset count
      - 3.2.1.10 Energy Update Rate
    - 3.2.2 Communication Parameter selection screen
      - 3.2.2.1 Address Setting
      - 3.2.2.2 RS 485 Baud rate
      - 3.2.2.3 RS 485 Parity selection & Stop bit Selection

- 3.2.3 Reset Parameter selection screen
  - 3.2.3.1 Resetting Parameter
- 3.2.4 Output Option selection screen (menu)
  - 3.2.4.1 Relay 1 output selection menu
  - 3.2.4.2 Relay 2 output selection menu
  - 3.2.4.3 Parameter setting for Analog Output-1
  - 3.2.4.4 Parameter setting for Analog Output-2
- 3.2.5 Brightness & Contrast
- 3.2.6 RGB Color Code
- 4. Touch screen calibration.
- 5. Analog Output
- 6. Relay Output
  - 6.1 Pulse output
- 7. RS 485 (Modbus) output
- 8. Phaser Diagram
- 9. Installation
  - 9.1 EMC Installation Requirements
  - 9.2 Case Dimensions and Panel Cut-out
  - 9.3 Wiring
  - 9.4 Auxiliary Supply
  - 9.5 Fusing
  - 9.6 Earth / Ground Connections
- 10. Connection Diagrams
- 11. Specification
- 12. Connection for Optional Pulse output / RS 485 /Analog Output

## 1. Introduction

This instrument is a panel mounted 96 x 96mm DIN Quadratic Digital metering system for the measurement of important electrical parameters like AC voltage, AC Current, Frequency, Power, Energy(Active / Reactive / Apparent) . The instrument integrates accurate measurement of technology (All Voltage & Current measurements are True RMS upto 15th Harmonic) with 320x240 Pixels touch screen TFT LCD display.



This instrument can be configured and programmed at site for the following: PT Primary, CT Primary, PT Secondary ,CT Secondary (5A or1A) and 3 phase 3W or 3 Phase 4W system.

The front panel has a 3.5" Touch Screen through which the user can move across the available measurement readings, reset the energy, Min/Max (System Voltage and System Current) and configure the product settings.

**TABLE 1:**

| <b>Measured Parameters</b>                  | <b>Units of Measurement</b> |
|---|-----------------------------|
| System Voltage                              | Volts                       |
| System Current                              | Amps                        |
| Voltage VL1-N(4wire only)                   | Volts                       |
| Voltage VL2-N(4wire only)                   | Volts                       |
| Voltage VL3-N(4wire only)                   | Volts                       |
| Voltage VL1-L2 ( for 3 / 4 wire)            | Volts                       |
| Voltage VL2-L3 ( for 3 / 4 wire)            | Volts                       |
| Voltage VL3-L1 ( for 3 / 4 wire)            | Volts                       |
| Current L1( for 3 / 4 wire)                 | Amps                        |
| Current L2( for 3 / 4 wire)                 | Amps                        |
| Current L3( for 3 / 4 wire)                 | Amps                        |
| Neutral Current ( 4 wire only )             | Amps                        |
| Frequency                                   | Hz                          |
| Active Power                                | Kwatts                      |
| Reactive Power                              | KVAr                        |
| Apparent Power                              | KVA                         |
| Power Factor                                | —                           |
| Phase Angle (1P2W/3P4W)                     | Degree                      |
| Active Import Energy (8 Digit resolution)   | kWh                         |
| Active Export Energy (8 Digit resolution)   | kWh                         |
| Reactive Import Energy (8 Digit resolution) | kVArh                       |
| Reactive Export Energy (8 Digit resolution) | kVArh                       |
| Apparent Energy (8 Digit resolution)        | kVAh                        |

| Measured Parameters   | Units of Measurement |
|---|----------------------|
| V1 THD* ( for 3 / 4 wire)                                     | %                    |
| V2 THD* ( for 3 / 4 wire)                                     | %                    |
| V3 THD* ( for 3 / 4 wire)                                     | %                    |
| I1 THD ( for 3 / 4 wire)                                      | %                    |
| I2 THD ( for 3 / 4 wire)                                      | %                    |
| I3 THD ( for 3 / 4 wire)                                      | %                    |
| System Voltage THD  | %                    |
| System Current THD  | %                    |
| Pictorial representation of Phasor Diagram (1P2W / 3P4W)      | —                    |
| Pictorial representation of Voltage Waveform                  | —                    |
| Pictorial representation of Current Waveform                  | —                    |
| Pictorial representation of VA Waveform per phase(1P2W /3P4W) | —                    |

**\*Note : THD Parameters are L-N in case of 3P 4W & L-L in case of 3P 3W .**

## 2. Measurement Reading Screens

In normal operation the user is presented with one of the measurement reading screens out of several screens. These screens from particular submenu may be scrolled through one at a time in incremental order by touching the "➡ key" and in decremental order by touching "⬅ key" on that screen.

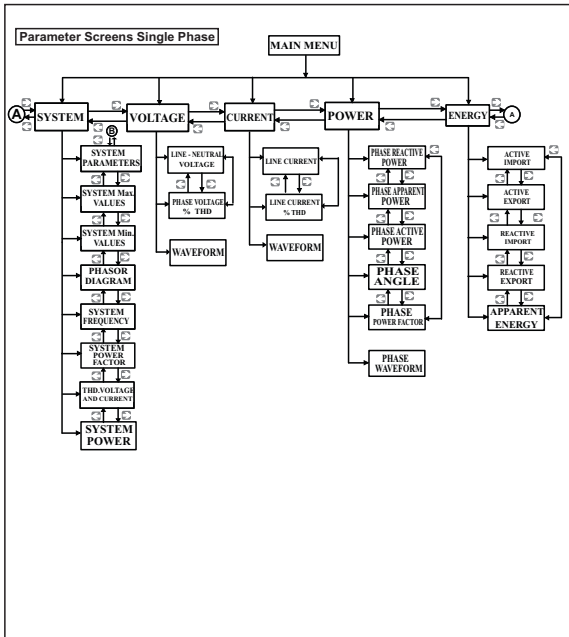



Parameter Screens 3 Phase

MAIN MENU

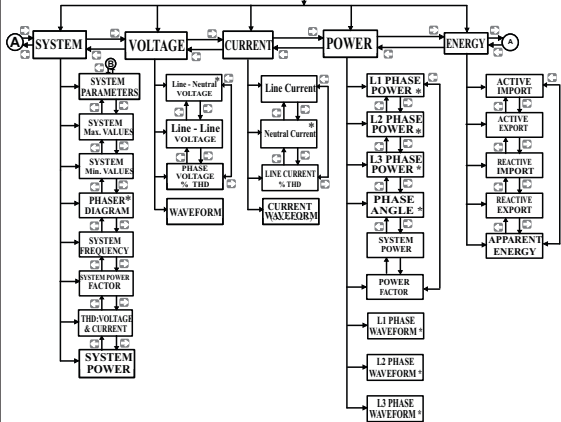

# Setup Parameter Screens

PASSWORD

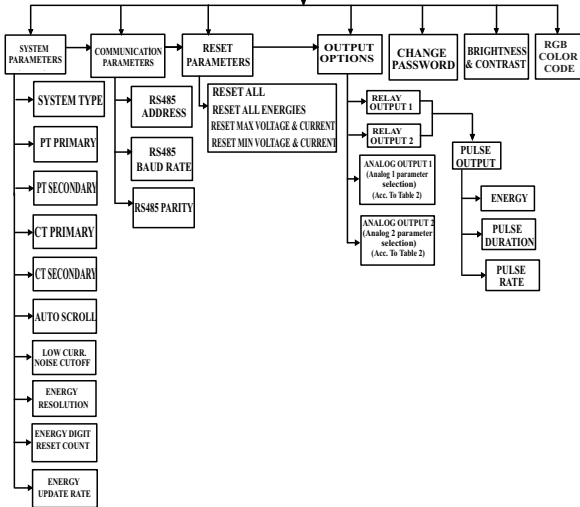

### 3. Programming

The following sections comprise step by step procedures for configuring the instrument for individual user requirements.

To access the set-up screens touch on the "⚙️ SETUP" icon in Main Menu. This will take the User into the Password Protection Entry Stage(Section 3.1).

#### 3.1. Password Protection

Password protection can be enabled to prevent unauthorised access to set-up screens, by default password is "0000".

Password protection is enabled by selecting any four digit number.



After touching "⚙️ SETUP" icon Password protection screen is displayed. Screen consists of 0 to 9 digit input keypad for entering the password very similar to any calculator in touchscreen mobile. "Enter Password" is displayed on screen at start so that user can enter password using displayed keypad.

Touching "1" key" will display 1 in display area, similarly user can enter remaining 3 digits.

For deleting any digit while entering password, user can touch "DEL" key".

After entering the complete password user needs to confirm password by touching "ENTER" key".

##### **Password confirmed.**

If Entered password is correct then "Password Accepted" is displayed on screen & user will on screen & user will enter into setup menu.

##### **Password Incorrect.**

If Entered password is wrong then "Password Rejected" is displayed on screen & user need to re-enter the password

After wrong password is entered, user needs to touch "ENTER" key " for trying another password.

### 3.1.1 Change Password



Change Password Option is the second last option in list of "SETUP" submenu, so can be accessed by a simple touch on " Change Password" button.

In this screen user first needs to enter the current password.



After input of correct password, "PASSWORD ACCEPTED" is displayed & now user can enter the new 4 digit password.



**New Password confirmed.**

After entering new password user needs to touch "  key" to confirm.

After confirming "PASSWORD CHANGED" is displayed on screen, which ensures successful changing of the password.

### 3.2 Menu selection.

After entering in the SUBMENU 6 - SETUP, user will be asked to enter password & after input of correct password list of following parameters will be displayed on screen :-

3.2.1 SYSTEM PARAMETERS

3.2.2 COMMUNICATION PARAMETERS

### 3.2.3 RESET PARAMETERS

### 3.2.4 OUTPUT OPTIONS

### 3.2.5 BRIGHTNESS & CONTRAST

Touching on SYSTEM PARAMETER will open the system parameters list screen. Then these screens from particular parameter may be scrolled through one at a time in incremental order by touching the "➡ key" and in decremental order by touching the "⬅ key" on given touch screen.

## 3.2.1 System Parameters Selection

After entering in the "SYSTEM PARAMETERS", List of following parameters will be displayed :-

### 3.2.1.1 SYSTEM TYPE

### 3.2.1.2 PT PRIMARY

### 3.2.1.3 CT PRIMARY

### 3.2.1.4 CT SECONDARY

### 3.2.1.5 AUTO SCROLL

### 3.2.1.6 LOW CURRENT NOISE CUTOFF

### 3.2.1.7 ENERGY RESOLUTION

### 3.2.1.8 ENERGY DIGIT RESET COUNT

### 3.2.1.9 ENERGY UPDATE RATE

### 3.2.1.1 System Type



This screen is used to set the system type .

Two types: 3 phase 3 wire & 3 phase 4 wire system are displayed on screen. Touching radio button in front of particular type will select that type.

Touch on "  key" will confirm the system type.

Touching the "  key" will keep the old selected setting and will return to previous menu.

Note : If system type is changed, relay parameter selection & analog output selection will be set to NONE.

### 3.2.1.2 Potential Transformer Primary Value

The nominal full scale voltage will be displayed as Line to Line Voltages for 3 Phase 3 wire and 3 Phase 4 wire and 1 Phase 2 wire for Single Phase.



This screen can be accessed only from system parameters list menu. Here again 0 to 9 digit input keypad is provided to set value of PT Primary, & user can confirm this value with a simple touch "ENTER" key". "K" key" is used to multiply value by 1000.

In case presently displayed Potential Transformer Primary value together with the Current Transformer Primary value, previously set, would result in a maximum power of greater than 666.6 MVA per phase,"Invalid value" will be displayed. Then the valid range will be displayed.

Valid range of PT primary setting value is from **100V L-L to 692.8KV L-L**.

If value outside the range is entered, It will display "INVALID VALUE" followed by correct range of parameter.

### 3.2.1.3 Potential Transformer secondary Value

The value must be set to the nominal full scale secondary voltage which will be obtained from the Transformer when the potential transformer(PT)primary is supplied with the voltage defined in 3.2.1.2 potential transformer primary voltage. The ratio of full scale primary to full scale secondary is defined as the transformer ratio.

This screen can be accessed only from system parameters list menu. Here again 0 to 9 digit input keypad is provided to set value of PT Secondary, & user can confirm this value with a simple touch on "ENTER" key".

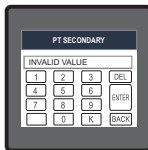

The Valid range of instrument is from 100 to 600V

If value outside the range is entered, It will display "INVALID VALUE" followed by correct range of parameter.

### 3.2.1.4 Current Transformer Primary Value

The nominal Full Scale Current that will be displayed as the Line currents. This screen enables the user to display the Line currents inclusive of any transformer ratios, the values displayed represent the Current in Amps.



This screen can be accessed only from system parameters list menu. Here again 0 to 9 digit input keypad is provided to set value of CT Primary & user can confirm this value with a simple touch on "ENTER" key. "K" key is used to multiply value by 1000.

In case presently displayed Current Transformer Primary Value together with the Potential Transformer Primary Value results in a

maximum power of greater than 666.6 MVA, "invalid value" will be displayed. Example: If primary value of PT is set as 692.8kV L-L (max value) then primary value of Current is restricted to 1157A.

The "Maximum Power" restriction of 666.6 MVA refers to 120% of nominal current and 120% of nominal voltage, i.e, 462.96 MVA nominal power per phase.



Valid range of CT primary setting value is from 1 to 9999. If value outside the range is entered, It will display "INVALID VALUE" followed by correct range of parameter.

### 3.2.1.5 Current Transformer Secondary Value

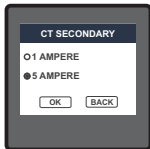

This screen is used to set the secondary value for Current Transformer. Two options: 1 AMPERE & 5 AMPERE are displayed on screen. Touching radio button in front of particular option will select that option. Touch on "  " key" will confirm the setting. Touching the "  " key" will keep the old selected setting and will return to previous menu.

### 3.2.1.6 Auto Scrolling

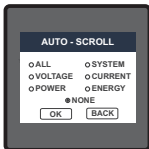

This screen allows user to enable screen scrolling. Seven options : ALL, SYSTEM, VOLTAGE, CURRENT POWER, ENERGY & NONE are displayed on screen. Touching radio button in front of particular option will select that option. Selecting particular option means, only screens which are under that submenu will be scrolled automatically. Selecting NONE will disable Auto-Scroll. Touch on "  " key" will confirm the setting.

Touching the "  " key" will keep the old selected setting and will return to previous menu.

While in Auto-scrolling mode, touch sense for entire screen will be disabled except for the top right most corner where "A" symbol would be displayed stating that meter is in Auto-scroll mode.

Touching on "A" will show two options "ON" and "OFF". Touching on "ON" will continue auto scrolling & touching on "OFF" will stop auto-scrolling & return to normal mode.



### 3.2.1.7 Low Current noise cutoff.

This screen allows the user to set Low noise current cutoff in mA.



Two options, 0 MILLI-AMPERE & 30 MILLI-AMPERE are displayed on screen. Touching radio button in front of particular option will select that option.

Touch on "  key" will confirm the setting.

Touching the "  key" will keep the old selected setting and will return to previous menu.

### 3.2.1.8 ENERGY RESOLUTION

This screen enable user to set energy in terms of Wh / kWh / MWh on Rs485 Output

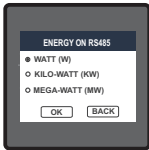

depending as per the user's requirement .

This setting is applicable for all types of energy.

Three options: WATT, KILO-WATT & MEGA-WATT are displayed on screen. Touching radio button in front of particular option will select that option.

Touch on "  key" will confirm the setting.

Touching the "  key" will keep the old selected setting and will return to previous menu.

**Note : Default value is set to 'WATT' i.e. Energy on Modbus will be in terms of Wh/VArh/VAh/Ah respectively.**

### 3.2.1.9 ENERGY DIGIT RESET COUNT (ROLLOVER COUNT)

This screen enables the user for setting maximum energy count after which energy will rollover to zero depending on the setting of Wh, kWh & Mwh in Energy resolution option.

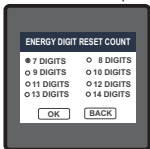

If Energy resolution is in WATT then rollover count can be from 7 to 14 DIGITS.

If Energy resolution is in KILO-WATT then rollover count can be from 7 to 12 DIGITS.

If Energy resolution is in MEGA-WATT then rollover count can be from 7 to 9 DIGITS. Touching radio button in front of particular option will select that option.

Touch on " **OK** " key" will confirm the setting.

Touching the " **BACK** " key" will keep the old selected setting and will return to previous menu.

**Note :-**

- 1) Default value of energy digit reset count is set to "14" i.e if energy crosses the 14 digit count it will rollover to zero.
- 2) If Energy Resolution is set to kW & energy digit reset count is set to 12, Energy screen on display will show "-----" i.e energy overflow when energy crosses the 11 digit count.
- 3) If Energy Resolution is set to MW & energy digit reset count is set to 9, Energy screen on display will show "-----" i.e energy overflow when energy crosses the 8 digit count.

### 3.2.1.10 Energy Update Rate



This screen allows user to enter energy update rate in min.

After entering particular value in min. the energy will be updated on modbus location from 30145 to 30153 of 3X register as per value that user has entered.

User can set value from 1 min to 60 min. If user enters value more than 60 min. then "INVALID VALUE" will be displayed and valid band will be shown.

Touching the " **BACK** " key" will keep the old selected setting and will return to previous menu.

For example user has entered 2 min as energy update rate. then after every 2 min, energy counts will be updated on modbus.

## 3.2.2 Communication Parameter Selection :

After entering in the "COMMUNICATION PARAMETERS" list of following parameters will be displayed

- 3.2.2.1 RS485 ADDRESS
- 3.2.2.2 RS485 BAUD RATE
- 3.2.2.3 RS485 PARITY

### 3.2.2.1 RS485 Address Setting



This screen applies to the RS 485 output only. This screen allows the user to set RS485 address parameter for the instrument.

This screen can be accessed only from Communication Parameters List menu.

Here again 0 to 9 digit input keypad is provided to set RS485 address & user can confirm this value with a simple touch on " key".



The range of allowable address is 1 to 247.

If value outside the range is entered, it will display "INVALID VALUE" followed by the correct range of parameter.

### 3.2.2.2 RS 485 Baud Rate

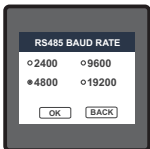

This screen allows the user to set Baud Rate of RS 485 port. Four options: 2400, 4800, 9600, 19200 Bauds are displayed on screen. Touching radio button in front of particular option will select that option.

Touch on " key" will confirm the setting.

Touching the " key" will keep the old selected setting and will Return to previous menu.

### 3.2.2.3 RS 485 Parity & Stop bit Selection



This screen allows the user to set Parity & number of stop bits. Four options: ODD PARITY WITH ONE STOP BIT, NO PARITY WITH ONE STOP BIT, NO PARITY WITH TWO STOP BITS, EVEN PARITY WITH ONE STOP BIT are displayed on screen. Touching radio button in front of particular option will select that option. Touch on “**OK** key” will confirm the setting. Touching the “**BACK** key” will keep the old selected setting and will return to previous menu.

### 3.2.3 Reset Parameter Selection:-

#### 3.2.3.1 Resetting Parameter



These screens allow the users to reset all the parameters like Energy, Min, Max Voltage and Current. For resetting specific parameter user can touch on that particular parameter.



Touching on any parameter will display the confirmation dialog, now a touch on “**YES** key” will confirm the resetting of that particular Parameter. Touching on “**NO** key” will move back to Reset parameters menu. For example resetting All Energies will display a confirmation dialog as shown in the screen beside. User can reset other parameters in similar manner.

### 3.2.4. Output Option selection menu

After entering in the "OUTPUT OPTIONS", List of following parameters will be displayed :-

3.2.4.1 RELAY-1

3.2.4.2 RELAY-2

#### 3.2.4.1 Relay1 output Selection menu

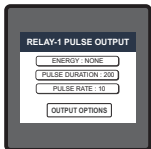

This screen applies to the Relay1 Output option Selection .

Touching any option will open screens of parameters related to that option.

Touch on " **OUTPUT OPTIONS** " key" will take back to Output Options screen.

#### 3.2.4.1.1 Pulse output

After entering in the "RELAY-1 OUTPUT", List of following parameters will be displayed.

3.2.4.1.1.1 ENERGY

3.2.4.1.1.2 PULSE DURATION

3.2.4.1.1.3 PULSE RATE

These settings are used to assign Relay1 in Pulse output mode.

### 3.2.4.1.1.1 Assignment of Energy to pulse output (Relay 1) :

This screen allows the user to assign energy to pulse output (for Relay 1)

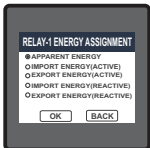

Following six options are displayed:-

Apparent Energy                      Import Energy ( Active )  
Export Energy ( Active )              Import Energy (Reactive)  
Export Energy (Reactive)

Touching radio button in front of any particular option will select that option. Touch on "  " key" will confirm the setting.

Touching the "  " key" will keep the old selected setting and will return to previous menu.

### 3.2.4.1.1.2 Pulse Duration Selection:

This screen applies only to the Pulsed output mode of both the relays.



This screen allows the user to set Relay energisation time in milliseconds.

Three options: 60, 100, 200 ms are displayed on screen. Touching radio button in front of particular option will select that option.

Touch on "  " key" will confirm the setting.

Touching the "  " key" will keep the old selected setting and will return to previous menu.

### 3.2.4.1.1.3 Pulse Rate

This screen applies only to the Pulsed output mode of both the relays.



The screen allows user to set the energy pulse rate divisor.

Divisor values can be selected through 1,10, 100,1000. Touching radio button in front of particular value will select that value.

Touch on "  " key" will confirm the setting.

Touching the "  " key" will keep the old selected setting and will return to previous menu.

Pulse rate divisor is set to 1, when Energy on Rs485 is set to kWh or MWh.

### **3.2.4.2 Relay 2 Output Selection**

Configuration of Relay 2 for Pulse or Limit Output is same as Relay 1. If you Select the Pulse output option for Relay 1 same setting will be applicable for Relay 2 except assignment of energy to Pulse output (i.e. Energy assignment of both relay can be different.)

### **3.2.4.3 Parameter setting for Analog Output 1 ( Optional )**

This option allows the user to set analog output 1 to corresponding measured parameter. A simple touch on "ANALOG-1"row will open screen having list of parameters.( Refer table2 for Analog Parameter")

Touch on "  key" will confirm the setting.

Touching the "  key" will keep the old selected setting and will return to previous menu.

### **3.2.4.4 Parameter setting for Analog Output 2 ( Optional )**

This option allows the user to set analog output 2 to corresponding measured parameter. A simple touch on "ANALOG-2"row will open screen having list of parameters.( Refer table2 for Analog Parameter)

Touch on "  key" will confirm the setting.

Touching the "  key" will keep the old selected setting and will return to previous menu.

### 3.2.5 Brightness & Contrast



The brightness & contrast of the TFT LCD screen can be varied by the user by sliding the sliders. Touching the "  " key" will confirm the current brightness contrast setting.

Touching the DEFAULT key will set brightness and contrast as per factory settings. Touching the BACK key will move back to the setup menu without making any changes.

### 3.2.6 RGB Color Code (only for 3 Phase 3 Wire / 4 Wire)



This screen allows user to set the values of Red, Green and Blue components of colors used to display the parameters of all three phases. Different colors can be assigned to each phase using combination of Red, Green and Blue component values. L1,L2,L3 will be set to the assigned color.

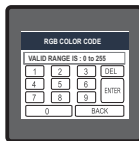

To set these values, touch the corresponding rectangular section, 0 to 9 digit input keypad will appear. After entering the value using this keypad, user can confirm this value with a simple touch on "  " key".

"  " key" is used to go back to previous screen.

The allowable range for these values is 0 to 255. If a value outside this range is entered, it will display " VALID RANGE IS : 0 TO 255".

**NOTE :** Colors similar to background are not recommended.



## Standard color combinations

| COLOR      | R   | G   | B   |
|------------|-----|-----|-----|
| Black      | 0   | 0   | 0   |
| Blue       | 0   | 0   | 255 |
| Brass      | 181 | 166 | 66  |
| Bronze     | 204 | 128 | 51  |
| Brown      | 166 | 41  | 41  |
| Copper     | 184 | 115 | 51  |
| Dark Blue  | 0   | 0   | 140 |
| Dark Brown | 102 | 66  | 33  |
| Dark Green | 0   | 51  | 33  |

| COLOR       | R   | G   | B   |
|-------------|-----|-----|-----|
| Dark Pink   | 232 | 84  | 128 |
| Dark Purple | 48  | 26  | 51  |
| Dark Red    | 140 | 0   | 0   |
| Dark Violet | 148 | 0   | 212 |
| Dark Yellow | 156 | 135 | 13  |
| Gold        | 212 | 176 | 56  |
| Gray        | 128 | 128 | 128 |
| Green       | 0   | 255 | 0   |
| Indigo      | 74  | 0   | 130 |

| COLOR      | R   | G   | B   |
|------------|-----|-----|-----|
| Light Blue | 173 | 217 | 230 |
| Maroon     | 176 | 48  | 97  |
| Pink       | 255 | 191 | 204 |
| Purple     | 161 | 33  | 240 |
| Red        | 255 | 0   | 0   |
| Silver     | 191 | 191 | 191 |
| Violet     | 143 | 0   | 255 |
| White      | 255 | 255 | 255 |
| Yellow     | 255 | 255 | 0   |

## 4 Touch screen calibration

This instrument is able to perform calibration to ensure the proper operation of the units touch screen functionalities. The calibration procedure will correct the problem of out of tolerance touch screen malfunction. Note that errors corrected by this calibration procedure are specific only to touch screen operation.



For starting touch screen calibration, touch the screen any where for 1 sec at system reset. After that touch screen calibration will start & the message shown besides will be displayed. Touch the screen to continue.

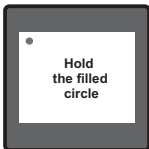

Follow the instructions displayed. Press & hold the center of the filled red circle for at least 2 seconds. Release when message for release is being displayed. For accurate results try to touch the center of the filled circle.

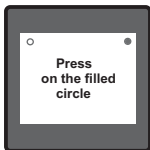

Repeat the same procedure for the remaining 3 corner circles.

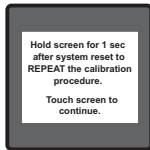

After successful calibration, the message shown besides would be displayed. Touch the screen to continue.



If the touch screen was not calibrated properly, "Error in calibration" message would be shown & the user will be asked to recalibrate the touch screen. In such case the meter will retain the previously stored touch - screen calibration values unless a successful calibration is being performed.

## 5. Analog Output ( optional ) :

This module provides two d.c. isolated outputs . There are two output

- 1) Two 0 - 1mA outputs , internally powered .
- 2) Two 4 - 20mA outputs , internally powered .

The 0 -1mA output module has an 0V return on each end of the 4 way connector  
( Please refer section 15 for connection details )

On both modules the output signals are present on pins A1(Analog Output 1) & A2 (Analog Output 2)

These outputs can be individually assigned to represent any one of the measured and displayed Parameters.

All settlings are user configurable via the user interface screen. See Analog o/p selection for details .

\* Note : Refer diagrams 1 & 2

### Diagram 1 : ( 4 -20 mA )

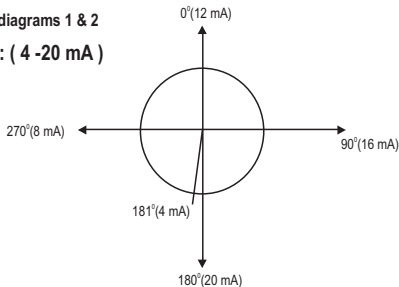

**Diagram 2 : ( 0 - 1 mA )**

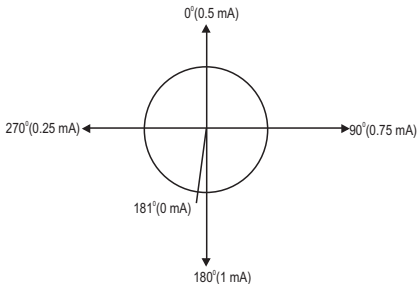

**TABLE 2 : Parameter for Analog**

| Sr. No. | Parameter         | 1P 2W | 3P 4W | 3P 3W | Range     |
|---------|-------------------|-------|-------|-------|-----------|
| 0       | None              | ✓     | ✓     | ✓     | -         |
| 1       | INPUT VOLTAGE L1  | ✓     | ✓     | ✓     | 0 - 100 % |
| 2       | INPUT VOLTAGE L2  | ✗     | ✓     | ✓     | 0 - 100 % |
| 3       | INPUT VOLTAGE L3  | ✗     | ✓     | ✓     | 0 - 100 % |
| 4       | INPUT CURRENT IL1 | ✓     | ✓     | ✓     | 0 - 100 % |
| 5       | INPUT CURRENT IL2 | ✗     | ✓     | ✓     | 0 - 100 % |
| 6       | INPUT CURRENT IL3 | ✗     | ✓     | ✓     | 0 - 100 % |
| 7       | ACTIVE POWER L1   | ✓     | ✓     | ✗     | 0 - 120 % |

**Note :** Parameters 1,2,3 are L-N Voltage for 3P 4W & L-L Voltage for 3P 3W.

| Sr. No. | Parameter          | 1P 2W | 3P 4W | 3P 3W | Range           |
|---------|--------------------|-------|-------|-------|-----------------|
| 8       | ACTIVE POWER L2    | x     | ✓     | x     | 0 - 120 %       |
| 9       | ACTIVE POWER L3    | x     | ✓     | x     | 0 - 120 %       |
| 10      | APPARENT POWER L1  | ✓     | ✓     | x     | 0 - 120 %       |
| 11      | APPARENT POWER L2  | x     | ✓     | x     | 0 - 120 %       |
| 12      | APPARENT POWER L3  | x     | ✓     | x     | 0 - 120 %       |
| 13      | REACTIVE POWER L1  | ✓     | ✓     | x     | 0 - 120 %       |
| 14      | REACTIVE POWER L2  | x     | ✓     | x     | 0 - 120 %       |
| 15      | REACTIVE POWER L3  | x     | ✓     | x     | 0 - 120 %       |
| 16      | POWER FACTOR L1    | ✓     | ✓     | x     | 181°/ 0 / -180° |
| 17      | POWER FACTOR L2    | x     | ✓     | x     | 181°/ 0 / -180° |
| 18      | POWER FACTOR L3    | x     | ✓     | x     | 181°/ 0 / -180° |
| 19      | PHASE ANGLE L1     | ✓     | ✓     | x     | 181°/ 0 / -180° |
| 20      | PHASE ANGLE L2     | x     | ✓     | x     | 181°/ 0 / -180° |
| 21      | PHASE ANGLE L3     | x     | ✓     | x     | 181°/ 0 / -180° |
| 22      | VOLTAGE AVG        | x     | ✓     | ✓     | 0 - 100 %       |
| 24      | CURRENT AVG        | x     | ✓     | ✓     | 0 - 100 %       |
| 27      | ACTIVE POWER SUM   | x     | ✓     | ✓     | 0 - 120 %       |
| 29      | APPARENT POWER SUM | x     | ✓     | ✓     | 0 - 120 %       |
| 31      | REACTIVE POWER SUM | x     | ✓     | ✓     | 0 - 120 %       |
| 32      | POWER FACTOR AVG   | x     | ✓     | ✓     | 181°/ 0 / -180° |
| 34      | PHASE ANGLE AVG    | x     | ✓     | ✓     | 181°/ 0 / -180° |
| 36      | FREQUENCY          | ✓     | ✓     | ✓     | 45 to 66 Hz     |
| 101     | INPUT VOLTAGE L12  | x     | ✓     | x     | 0 - 100 %       |
| 102     | INPUT VOLTAGE L23  | x     | ✓     | x     | 0 - 100 %       |
| 103     | INPUT VOLTAGE L31  | x     | ✓     | x     | 0 - 100 %       |
| 113     | NEUTRAL CURRENT    | x     | ✓     | x     | 0 - 100 %       |

## 6. Relay output (Optional) :

This instrument is provided with either 1 or 2 relay for pulse output .

### Pulse Output :

Pulse output is the potential free, very fast acting relay contact which can be used to drive an external mechanical counter for energy measurement.

This instrument's pulse output can be configured to any of the following parameter through setup parameter screen

- |                             |                             |
|-----------------------------|-----------------------------|
| 1) Active Energy (Import)   | 4) Reactive Energy (Export) |
| 2) Active Energy (Export)   | 5) Apparent Energy          |
| 3) Reactive Energy (Import) |                             |

**TABLE 3 : Energy Pulse Rate Divisor**

### 1. For Energy Output in Wh

| Pulse rate                             |               |               |
|--|---------------|---------------|
| Divisor                                | Pulse         | System Power* |
| 1                                      | 1per Wh       | Up to 3600W   |
|  | 1per kWh      | Up to 3600kW  |
|  | 1per Mwh      | Above 3600kW  |
| 10                                     | 1per 10Wh     | Up to 3600W   |
|  | 1per 10kWh    | Up to 3600kW  |
|  | 1per 10MWh    | Above 3600kW  |
| 100                                    | 1per 100Wh    | Up to 3600W   |
|  | 1per 100kWh   | Up to 3600kW  |
|  | 1per 100MWh   | Above 3600kW  |
| 1000                                   | 1 per 1000Wh  | Up to 3600W   |
|  | 1 per 1000kWh | Up to 3600kW  |
|  | 1per 1000MWh  | Above 3600kW  |
| Pulse Duration 60 ms, 100 ms or 200 ms |               |               |

### 2. For Energy Output in Kwh

| Pulse rate |               |               |
|------------|---------------|---------------|
| Divisor    | Pulse         | System Power* |
| 1          | 1 per kWh     | Up to 3600W   |
|            | 1 per 1000kWh | Up to 3600kW  |
|            | 1 per 1000MWh | Above 3600kW  |

### 3. For Energy Output in Mwh

| Pulse rate |               |               |
|------------|---------------|---------------|
| Divisor    | Pulse         | System Power* |
| 1          | 1 per Mwh     | Up to 3600W   |
|            | 1 per 1000Mwh | Up to 3600kW  |
|            | 1 per 1000Gwh | Above 3600kW  |

Above options are also applicable for Apparent and Reactive Energy.

\* System power =  $3 \times CT(\text{Primary}) \times PT(\text{Primary})_{L-N}$  for 3 Phase 4 Wire  
 System power =  $\text{Root}3 \times CT(\text{Primary}) \times PT(\text{Primary})_{L-L}$  for 3 Phase 3 Wire

## 7. RS 485 ( ModBus ) Output :

This instrument supports MODBUS (RS485) RTU protocol( 2-wire ) .

Connection should be made using twisted pair shielded cable. All "A" and "B" connections are daisy chained together. The screens should also be connected to the "Gnd" terminal. To avoid the possibility of loop currents, an Earth connection should be made at one point on the network. Loop (ring) topology does not require any termination load. Line topology may or may not require terminating loads depending on the type and length of cable used. The impedance of the termination load should match the impedance of the cable and be at both ends of the line. The cable should be terminated at each end with a 120 ohm (1/4 Watt min.) resistor.

RS 485 network supports maximum length of 1.2km. Including the Master, a maximum of 32 instruments can be connected in Rs485 network. The permissible address range for the instruments is between 1 and 247 for 32 instruments. Broadcast Mode (address 0) is not allowed.

The maximum latency time for the instrument is 200ms i.e. this is the amount of time that can pass before the first response character is output.

After sending any query through software ( of the Master ) , it must allow 200ms of time to elapse before assuming that the instrument is not going to respond. If slave does not respond within 200 ms, Master can ignore the previous query and can issue fresh query to the slave.

The each byte in RTU mode has following format:

|                             |  |
|-----------------------------|--|
|                             | 8-bit binary, hexadecimal 0-9, A-F<br>2 hexadecimal characters contained in each 8-bit field of the message  |
| <b>Format of Data Bytes</b> | 4 bytes (32 bits) per parameter.<br>Floating point format ( to IEEE 754)<br>Most significant byte first (Alternative least significant byte first)   |
| <b>Error Checking Bytes</b> | 2 byte Cyclical Redundancy Check (CRC)   |
| <b>Byte format</b>          | 1 start bit,<br>8 data bits, least significant bit sent first<br>1 bit for even/odd parity<br>1 stop bit if parity is used; 1 or 2 bits if no parity |

Communication Baud Rate is user selectable from the front panel between 2400, 4800, 9600, 19200 bps.

**Function code :**

|    |                            |  |
|----|----------------------------|--|
| 03 | Read Holding Registers     | Read content of read /write location ( 4X )      |
| 04 | Read input Registers       | Read content of read only location ( 3X )        |
| 16 | Presets Multiple Registers | Set the content of read / write locations ( 4X ) |

**Exception Cases :** An exception code will be generated when the instrument receives ModBus query with valid parity & error check but which contains some other error ( e.g. Attempt to set floating point variable to an invalid value ) The response generated will be "Function code" Ored with HEX (80H ). The exception codes are listed below



|    |                      |  |
|----|----------------------|--|
| 01 | Illegal function     | This function code is not supported by the instrument.   |
| 02 | Illegal Data Address | Attempt to access an invalid address or an attempt to read or write part of a floating point value |
| 03 | Illegal Data Value   | Attempt to set a floating point variable to an invalid value                                       |

### Accessing 3 X register for reading measured values:

Two consecutive 16 bit registers represent one parameter. Refer table 4 for the addresses of 3X registers (Parameters measured by the instruments).

Each parameter is held in the 3X registers. Modbus Code 04 is used to access all parameters.

#### Example :

To read parameter ,

Volts 3 : Start address = 04 (Hex)      Number of registers = 02

#### Note : Number of registers = Number of parameters x 2

Each Query for reading the data must be restricted to 20 parameters or less. Exceeding the 20 parameter limit will cause a ModBus exception code to be returned.

#### Query :

|                |               |                    |                   |                        |                        |          |          |
|----------------|---------------|--------------------|-------------------|------------------------|------------------------|----------|----------|
| 01 (Hex)       | 04 (Hex)      | 00 (Hex)           | 04(Hex)           | 00 (Hex)               | 02(Hex)                | 30 (Hex) | 0A (Hex) |
| Device Address | Function Code | Start Address High | Start Address Low | Number of Registers Hi | Number of Registers Lo | CRC Low  | CRC High |

Start Address High : Most significant 8 bits of starting address of the parameter requested.

Start Address low :Least significant 8 bits of starting address of the parameter requested.

Number of register Hi : Most significant 8 bits of Number of registers requested.

Number of register Lo : Least significant 8 bits of Number of registers requested.

**(Note : Two consecutive 16 bit register represent one parameter.)**

**Response: Volt3 (219.25V)**

|                |               |            |                          |                         |                          |                         |          |          |
|----------------|---------------|------------|--------------------------|-------------------------|--------------------------|-------------------------|----------|----------|
| 01 (Hex)       | 04 (Hex)      | 04 (Hex)   | 43 (Hex)                 | 5B (Hex)                | 41 (Hex)                 | 21 (Hex)                | 6F (Hex) | 9B (Hex) |
| Device Address | Function Code | Byte Count | Data Register1 High Byte | Data Register1 Low Byte | Data Register2 High Byte | Data Register2 Low Byte | CRC Low  | CRC High |

Byte Count : Total number of data bytes received.

Data register 1 High Byte : Most significant 8 bits of Data register 1 of the parameter requested.

Data register 1 Low Byte : Least significant 8 bits of Data register 1 of the parameter requested.

Data register 2 High Byte : Most significant 8 bits of Data register 2 of the parameter requested.

Data register 2 Low Byte : Least significant 8 bits of Data register 2 of the parameter requested.

**(Note : Two consecutive 16 bit register represent one parameter.)**

**Table 4 : 3 X register addresses (measured parameters)**

| Address (Register) | Sr. No. | Parameter | Modbus Start Address Hex |          | 1P 2W | 3P 4W | 3P 3W |
|--------------------|---------|-----------|--------------------------|----------|-------|-------|-------|
|                    |         |           | High Byte                | Low Byte |       |       |       |
| 30001              | 1       | Volts 1   | 00                       | 0        | ✓     | ✓     | ✓     |
| 30003              | 2       | Volts 2   | 00                       | 2        | ✗     | ✓     | ✓     |
| 30005              | 3       | Volts 3   | 00                       | 4        | ✗     | ✓     | ✓     |
| 30007              | 4       | Current 1 | 00                       | 6        | ✓     | ✓     | ✓     |
| 30009              | 5       | Current 2 | 00                       | 8        | ✗     | ✓     | ✓     |
| 30011              | 6       | Current 3 | 00                       | A        | ✗     | ✓     | ✓     |
| 30013              | 7       | W1        | 00                       | C        | ✓     | ✓     | ✗     |

| Address<br>(Register) | Sr.<br>No. | Parameter     | Modbus Start Address Hex |          | 1P 2W | 3P 4W | 3P 3W |
|-----------------------|------------|---------------|--------------------------|----------|-------|-------|-------|
|                       |            |               | High Byte                | Low Byte |       |       |       |
| 30015                 | 8          | W2            | 00                       | E        | x     | ✓     | x     |
| 30017                 | 9          | W3            | 00                       | 10       | x     | ✓     | x     |
| 30019                 | 10         | VA1           | 00                       | 12       | ✓     | ✓     | x     |
| 30021                 | 11         | VA2           | 00                       | 14       | x     | ✓     | x     |
| 30023                 | 12         | VA3           | 00                       | 16       | x     | ✓     | x     |
| 30025                 | 13         | VAR1          | 00                       | 18       | ✓     | ✓     | x     |
| 30027                 | 14         | VAR2          | 00                       | 1A       | ✓     | ✓     | x     |
| 30029                 | 15         | VAR3          | 00                       | 1C       | x     | ✓     | x     |
| 30031                 | 16         | PF1           | 00                       | 1E       | ✓     | ✓     | x     |
| 30033                 | 17         | PF2           | 00                       | 20       | x     | ✓     | x     |
| 30035                 | 18         | PF3           | 00                       | 22       | x     | ✓     | x     |
| 30037                 | 19         | Phase Angle 1 | 00                       | 24       | ✓     | ✓     | x     |
| 30039                 | 20         | Phase Angle 2 | 00                       | 26       | x     | ✓     | x     |
| 30041                 | 21         | Phase Angle 3 | 00                       | 28       | x     | ✓     | x     |
| 30043                 | 22         | Volts Ave     | 00                       | 2A       | x     | ✓     | ✓     |
| 30045                 | 23         | Volts Sum     | 00                       | 2C       | x     | ✓     | ✓     |
| 30047                 | 24         | Current Ave   | 00                       | 2E       | x     | ✓     | ✓     |
| 30049                 | 25         | Current Sum   | 00                       | 30       | x     | ✓     | ✓     |
| 30051                 | 26         | Watts Ave     | 00                       | 32       | x     | ✓     | ✓     |
| 30053                 | 27         | Watts Sum     | 00                       | 34       | x     | ✓     | ✓     |
| 30055                 | 28         | VA Ave        | 00                       | 36       | x     | ✓     | ✓     |
| 30057                 | 29         | VA Sum        | 00                       | 38       | x     | ✓     | ✓     |
| 30059                 | 30         | VAr Ave       | 00                       | 3A       | x     | ✓     | ✓     |
| 30061                 | 31         | VAr Sum       | 00                       | 3C       | x     | ✓     | ✓     |
| 30063                 | 32         | PF Ave        | 00                       | 3E       | x     | ✓     | ✓     |

| Address (Register) | Sr. No. | Parameter                  | Modbus Start Address Hex |          | 1P 2W | 3P 4W | 3P 3W |
|--------------------|---------|----------------------------|--------------------------|----------|-------|-------|-------|
|                    |         |                            | High Byte                | Low Byte |       |       |       |
| 30065              | 33      | PF Sum                     | 00                       | 40       | ✘     | ✓     | ✘     |
| 30067              | 34      | Phase Angle Ave            | 00                       | 42       | ✘     | ✓     | ✓     |
| 30069              | 35      | Phase Angle Sum            | 00                       | 44       | ✘     | ✓     | ✘     |
| 30071              | 36      | Freq                       | 00                       | 46       | ✓     | ✓     | ✓     |
| 30073              | 37      | Wh Import                  | 00                       | 48       | ✓     | ✓     | ✓     |
| 30075              | 38      | Wh Export                  | 00                       | 4A       | ✓     | ✓     | ✓     |
| 30077              | 39      | VARh Import                | 00                       | 4C       | ✓     | ✓     | ✓     |
| 30079              | 40      | VARh Export                | 00                       | 4E       | ✓     | ✓     | ✓     |
| 30081              | 41      | VAh                        | 00                       | 50       | ✓     | ✓     | ✓     |
| 30109              | 42      | Wh Import Overflow Count   | 00                       | 6C       | ✓     | ✓     | ✓     |
| 30111              | 43      | Wh Export Overflow Count   | 00                       | 6e       | ✓     | ✓     | ✓     |
| 30113              | 44      | Varh Import Overflow Count | 00                       | 70       | ✓     | ✓     | ✓     |
| 30115              | 45      | Varh Export Overflow Count | 00                       | 72       | ✓     | ✓     | ✓     |
| 30117              | 46      | Vah Overflow Count         | 00                       | 74       | ✓     | ✓     | ✓     |
| 30133              | 48      | Volts Ave Max              | 00                       | 84       | ✓     | ✓     | ✓     |
| 30135              | 49      | Volts Ave Min              | 00                       | 86       | ✓     | ✓     | ✓     |
| 30141              | 50      | Current Ave Max            | 00                       | 8C       | ✓     | ✓     | ✓     |
| 30143              | 51      | Current Ave Min            | 00                       | 8E       | ✓     | ✓     | ✓     |
| 30145              | 52      | Active Import Energy(Wh)*  | 00                       | 90       | ✓     | ✓     | ✓     |

| Address (Register) | Sr. No. | Parameter                      | Modbus Start Address Hex |          | 1P 2W | 3P 4W | 3P 3W |
|--------------------|---------|--------------------------------|--------------------------|----------|-------|-------|-------|
|                    |         |                                | High Byte                | Low Byte |       |       |       |
| 30147              | 53      | Active Export Energy (Wh)*     | 00                       | 92       | ✓     | ✓     | ✓     |
| 30149              | 54      | Reactive Import Energy (VARh)* | 00                       | 94       | ✓     | ✓     | ✓     |
| 30151              | 55      | Reactive Export Energy (VARh)* | 00                       | 96       | ✓     | ✓     | ✓     |
| 30153              | 56      | Apparent Energy (VAh)*         | 00                       | 98       | ✓     | ✓     | ✓     |
| 30197              | 57      | Model Number                   | 00                       | C4       | ✓     | ✓     | ✓     |
| 30199              | 58      | Version Number                 | 00                       | C6       | ✓     | ✓     | ✓     |
| 30201              | 59      | VL 1 - 2 ( Calculated )        | 00                       | C8       | ✗     | ✓     | ✗     |
| 30203              | 60      | VL 2 - 3 ( Calculated )        | 00                       | CA       | ✗     | ✓     | ✗     |
| 30205              | 61      | VL 3 - 1 ( Calculated )        | 00                       | CC       | ✗     | ✓     | ✗     |
| 30207              | 62      | V1 THD( % )                    | 00                       | CE       | ✗     | ✓     | ✓     |
| 30209              | 63      | V2 THD( % )                    | 00                       | D0       | ✗     | ✓     | ✓     |
| 30211              | 64      | V3 THD( % )                    | 00                       | D2       | ✗     | ✓     | ✓     |
| 30213              | 65      | I1 THD( % )                    | 00                       | D4       | ✗     | ✓     | ✓     |
| 30215              | 66      | I2 THD( % )                    | 00                       | D6       | ✗     | ✓     | ✓     |
| 30217              | 67      | I3 THD( % )                    | 00                       | D8       | ✗     | ✓     | ✓     |
| 30219              | 68      | System Voltage THD( % )        | 00                       | DA       | ✓     | ✓     | ✓     |
| 30221              | 69      | System Current THD( % )        | 00                       | DC       | ✓     | ✓     | ✓     |
| 30225              | 70      | I neutral                      | 00                       | E0       | ✓     | ✓     | ✗     |

Note : Parameters 1,2,3 are L-N Voltage for 3P 4W & L-L Voltage for 3P 3W .  
Parameters with \* mark are On Update Rate only.

### Accessing 4 X register for Reading & Writing :

Each setting is held in the 4X registers .ModBus code 03 is used to read the current setting and code 16 is used to write/change the setting. Refer Table 5 for 4 X Register

#### Example : Reading System type

System type : Start address = 0A (Hex) Number of registers = 02

Note :Number of registers = Number of Parameters x 2

**Query :**

|                        |          |
|------------------------|----------|
| Device Address         | 01 (Hex) |
| Function Code          | 03 (Hex) |
| Start Address High     | 00 (Hex) |
| Start Address Low      | 0A (Hex) |
| Number of Registers Hi | 00 (Hex) |
| Number of Registers Lo | 02 (Hex) |
| CRC Low                | E4 (Hex) |
| CRC High               | 09 (Hex) |

Start Address High : Most significant 8 bits of starting address of the parameter requested.

Start Address low :Least significant 8 bits of starting address of the parameter requested.

Number of register Hi : Most significant 8 bits of Number of registers requested.

Number of register Lo : Least significant 8 bits of Number of registers requested.

**(Note : Two consecutive 16 bit register represent one parameter.)**

**Response: System Type ( 3phase 4 wire = 3 )**

|                          |          |
|--------------------------|----------|
| Device Address           | 01 (Hex) |
| Function Code            | 03 (Hex) |
| Byte Count               | 04 (Hex) |
| Data Register1 High Byte | 40 (Hex) |
| Data Register1Low Byte   | 40 (Hex) |
| Data Register2 High Byte | 00 (Hex) |
| Data Register2 Low Byte  | 00(Hex)  |
| CRC Low                  | EE (Hex) |
| CRC High                 | 27 (Hex) |

Byte Count : Total number of data bytes received.

Data register 1 High Byte : Most significant 8 bits of Data register 1 of the parameter requested.

Data register 1 Low Byte : Least significant 8 bits of Data register 1 of the parameter requested.

Data register 2 High Byte : Most significant 8 bits of Data register 2 of the parameter requested.

Data register 2 Low Byte : Least significant 8 bits of Data register 2 of the parameter requested.

**(Note : Two consecutive 16 bit register represent one parameter.)**

### Example : Writing System type

System type : Start address = 0A (Hex) Number of registers = 02

Query:( Change System type to 3phase 3wire = 2 )

|                           |          |
|---------------------------|----------|
| Device Address            | 01 (Hex) |
| Function Code             | 10 (Hex) |
| Starting Address Hi       | 00 (Hex) |
| Starting Address Lo       | 0A(Hex)  |
| Number of Registers Hi    | 00 (Hex) |
| Number of Registers Lo    | 02(Hex)  |
| Byte Count                | 04 (Hex) |
| Data Register-1High Byte  | 40 (Hex) |
| Data Register-1 Low Byte  | 00(Hex)  |
| Data Register-2 High Byte | 00(Hex)  |
| Data Register-2 Low Byte  | 00(Hex)  |
| CRC Low                   | 66 (Hex) |
| CRC High                  | 10 (Hex) |

Byte Count : Total number of data bytes received.

Data register 1 High Byte : Most significant 8 bits of Data register 1 of the parameter requested.

Data register 1 Low Byte : Least significant 8 bits of Data register 1 of the parameter requested.

Data register 2 High Byte : Most significant 8 bits of Data register 2 of the parameter requested.

Data register 2 Low Byte : Least significant 8 bits of Data register 2 of the parameter requested.

**(Note : Two consecutive 16 bit register represent one parameter.)**

**Response:**

|                        |          |
|------------------------|----------|
| Device Address         | 01 (Hex) |
| Function Code          | 10 (Hex) |
| Start Address High     | 00 (Hex) |
| Start Address Low      | 0A(Hex)  |
| Number of Registers Hi | 00 (Hex) |
| Number of Registers Lo | 02(Hex)  |
| CRC Low                | 61 (Hex) |
| CRC High               | CA (Hex) |

Start Address High : Most significant 8 bits of starting address of the parameter requested.

Start Address low :Least significant 8 bits of starting address of the parameter requested.

Number of register Hi : Most significant 8 bits of Number of registers requested.

Number of register Lo : Least significant 8 bits of Number of registers requested.

**(Note : Two consecutive 16 bit register represent one parameter.)**

**Table 5 : 4 X register addresses**

| Address<br>(Register) | Parameter<br>No. | Parameter       | Read / Write | Modbus Start Address Hex |          |
|-----------------------|------------------|-----------------|--------------|--------------------------|----------|
|                       |                  |                 |              | High Byte                | Low Byte |
| 40005                 | 3                | Energy on RS485 | R/Wp         | 00                       | 04       |
| 40007                 | 4                | Sys Voltage     | R            | 00                       | 06       |
| 40009                 | 5                | Sys Current     | R            | 00                       | 08       |
| 40011                 | 6                | Sys Type        | R/Wp         | 00                       | 0A       |



| Address<br>(Register) | Parameter<br>No. | Parameter                      | Read / Write | Modbus Start Address Hex |          |
|-----------------------|------------------|--------------------------------|--------------|--------------------------|----------|
|                       |                  |                                |              | High Byte                | Low Byte |
| 40013                 | 7                | Pulse Width                    | R/Wp         | 00                       | 0C       |
| 40015                 | 8                | Reset parameters               | Wp           | 00                       | 0E       |
| 40019                 | 10               | RS 485 Set-up Code             | R/Wp         | 00                       | 12       |
| 40021                 | 11               | Node Address.                  | R/Wp         | 00                       | 14       |
| 40023                 | 12               | Pulse Divisor                  | R/Wp         | 00                       | 16       |
| 40025                 | 13               | Min Reset                      | Wp           | 00                       | 18       |
| 40027                 | 14               | Max Reset                      | Wp           | 00                       | 1A       |
| 40029                 | 15               | Analog Out 1- Para Sel         | R/Wp         | 00                       | 1C       |
| 40031                 | 16               | Analog Out 2- Para Sel         | R/Wp         | 00                       | 1E       |
| 40033                 | 17               | PT Primary                     | R/Wp         | 00                       | 20       |
| 40035                 | 18               | CT Primary                     | R/Wp         | 00                       | 22       |
| 40037                 | 19               | System Power                   | R            | 00                       | 24       |
| 40039                 | 20               | Energy digit reset count       | R/Wp         | 00                       | 26       |
| 40041                 | 21               | Register Order/Word Order      | R/Wp         | 00                       | 28       |
| 40043                 | 22               | CT Secondary                   | R/Wp         | 00                       | 2A       |
| 40045                 | 23               | PT Secondary                   | R/Wp         | 00                       | 2C       |
| 40049                 | 25               | Pulse1 Parameter select        | R/Wp         | 00                       | 30       |
| 40061                 | 31               | Pulse2/Limit2 Parameter select | R/Wp         | 00                       | 3C       |
| 40071                 | 36               | Password                       | R/W          | 00                       | 46       |
| 40077                 | 39               | -                              | -            | -                        | -        |
| 40079                 | 40               | 30mA Noise Current Elimination | R/Wp         | 00                       | 4E       |
| 40081                 | 41               | Energy Update Rate             | R/Wp         | 00                       | 50       |
| 40083                 | 42               | Model Number                   | R            | 00                       | 52       |

| Address<br>(Register) | Parameter<br>No. | Parameter                           | Read / Write | Modbus Start Address Hex |          |
|-----------------------|------------------|-------------------------------------|--------------|--------------------------|----------|
|                       |                  |                                     |              | High Byte                | Low Byte |
| 40085                 | 43               | Brightness                          | R/Wp         | 00                       | 54       |
| 40087                 | 44               | Contrast                            | R/Wp         | 00                       | 56       |
| 40089                 | 45               | Red color code of phase1            | R/Wp         | 00                       | 58       |
| 40091                 | 46               | Green color code of phase1          | R/Wp         | 00                       | 5A       |
| 40093                 | 47               | Blue color code of phase1           | R/Wp         | 00                       | 5C       |
| 40095                 | 48               | Red color code of phase2            | R/Wp         | 00                       | 5E       |
| 40097                 | 49               | Green color code of phase2          | R/Wp         | 00                       | 60       |
| 40099                 | 50               | Blue color code of phase2           | R/Wp         | 00                       | 62       |
| 40101                 | 51               | Red color code of phase3            | R/Wp         | 00                       | 64       |
| 40103                 | 52               | Green color code of phase3          | R/Wp         | 00                       | 66       |
| 40105                 | 53               | Blue color code of phase3           | R/Wp         | 00                       | 68       |
| 40107                 | 54               | Wh Import Start Count               | R/Wp         | 00                       | 6A       |
| 40109                 | 55               | Wh Export Start Count               | R/Wp         | 00                       | 6C       |
| 40111                 | 56               | Varh Import Start Count             | R/Wp         | 00                       | 6E       |
| 40113                 | 57               | Varh Export Start Count             | R/Wp         | 00                       | 70       |
| 40115                 | 58               | Vah Start Count                     | R/Wp         | 00                       | 72       |
| 40119                 | 60               | Wh Import Overflow Start Count      | R/Wp         | 00                       | 76       |
| 40121                 | 61               | Wh Export Overflow Start Count      | R/Wp         | 00                       | 78       |
| 40123                 | 62               | Varh Import Overflow Start<br>Count | R/Wp         | 00                       | 7A       |
| 40125                 | 63               | Varh Export Overflow Start<br>Count | R/Wp         | 00                       | 7C       |
| 40127                 | 64               | Vah Overflow Start Count            | R/Wp         | 00                       | 7E       |

## Explanation for 4 X register :

| Address | Parameter                | Description  |
|---------|--------------------------|--|
| 40005   | Energy display on Modbus | This address is used to set energy display on MODBUS in Wh, KWh & Mwh. Write one of the following value to this address.<br>1 = Energy in Wh.            2 = Energy in KWh.<br>3 = Energy in MWh.  |
| 40007   | System Voltage           | This address is read only and displays System Voltage  |
| 40009   | System Current           | This address is read only and displays System Current  |
| 40011   | System Type              | This address is used to set the System type.<br>Write one of the following value to this address.<br>1 = 1 Phase 2 Wire (Read only for 1P2W)<br>2 = 3 Phase 3 Wire    3 = 3 Phase 4 Wire.<br>Writing any other value will return error . |
| 40013   | Pulse Width of Relay     | This address is used to set <b>pulse width</b> of the Pulse output.<br>Write one of the following values to this address:<br>60 : 60 ms<br>100 : 100 ms<br>200 : 200 ms<br>Writing any other value will return error .                   |
| 40015   | Reset Parameters         | This address is used to reset the parameters by writing following.<br><b>0</b> : Energy reset <b>2</b> : Sys. Min reset<br><b>3</b> : Sys. Max reset <b>6</b> : Reset all .<br>Writing any other value will return an error.             |
| 40019   | Rs485 Set-up Code        | This address is used to set the baud rate, Parity, Number of   |

| Address | Parameter             | Description   |
|---------|-----------------------|---|
| 40021   | Node Address          | This register address is used to set Device address between 1 to 247 .  |
| 40023   | Pulse Divisor         | This address is used to set <b>pulse divisor</b> of the Pulse output. Write one of the following values to this address <b>for Wh</b> :<br>1 : Divisor 1<br>10 : Divisor 10<br>100 : Divisor 100<br><b>1000</b> : Divisor 1000 & in KWh & MWh Divisor will be <b>1 default</b> .<br>Writing any other value will return an error.<br>Pulse rate divisor is set to 1, when Energy on Rs485 is set to kWh or MWh. |
| 40025   | Min - Reset           | This address is used to reset the Min parameters value. Write Zero value to this register to reset the Min parameters. Writing any other value will return an error.  |
| 40027   | Max - Reset           | This address is used to reset the Max parameters value. Write Zero value to this register to reset the Max parameters. Writing any other value will return an error.  |
| 40029   | Analog Out 1-Para Set | This address is used to set the parameter for Analog Output 1. Write one of the parameter no. As per the options given in Table 2 for Analog Output Parameters. Writing any other value will return an error.   |
| 40031   | Analog Out 2-Para Set | This address is used to set the parameter for Analog Output 2. Write one of the parameter no. As per the options given in Table 2 for Analog Output Parameters. Writing any other value will return an error.   |

| Address | Parameter                | Description   |
|---------|--------------------------|---|
| 40033   | PT Primary               | This address allows the user to set PT Primary value. The maximum settable value is 692.8kV L-L depends on the per phase 666.6MVA Restriction of power combined with CT primary   |
| 40035   | CT Primary               | This address allows the user to set CT Primary value. The maximum settable value is 9999 & also depends on the per phase 666.6MVA Restriction of power combined with PT primary   |
| 40037   | Sys Power                | System Power (Read Only) is the Nominal system power based on the values of Nominal system volts and Nominal system current.  |
| 40039   | Energy digit Reset Count | This address is used to set the rollover count for energy. If Energy on Rs485 is in Wh rollover count can be from 7 to 14. If it is in KWh then rollover count can be from 7 to 12 & for MWh rollover count can be from 7 to 9.   |
| 40041   | Word Order               | Word Order controls the order in which the instrument receives or sends floating - point numbers:- normal or reversed register order. In normal mode, the two registers that make up a floating point numbers are sent most significant bytes first. In reversed register mode , the two registers that make up a floating point numbers are sent least significant bytes first. To set the mode, write the value '2141.0' into this register- the instrument will detect the order used to send this value and set that order for all ModBus transaction involving floating point numbers. |
| 40043   | CT secondary             | This address is used to read and write the CT secondary value write one of the following values to this address.<br>1=1A CT secondary<br>5=5A CT secondary  |

| Address | Parameter                      | Description   |
|---------|--------------------------------|---|
| 40045   | PT secondary                   | This address is used to read and write the PT secondary value. The valid range for PT Secondary is 100 VLL to 600 VLL.  |
| 40049   | Pulse 1 parameter select       | This address is used to assign the Parameter to Relay1 refer table 7.   |
| 40061   | Pulse 2 Parameter              | This address is used to assign the Parameter to Relay2 refer table 7.   |
| 40071   | Password                       | <p>This address is used to set &amp; reset the password. Valid Range of Password can be set is 0000 - 9999 .</p> <ol style="list-style-type: none"> <li>1) If password lock is present &amp; if this location is read it will return <b>zero</b>.</li> <li>2) If Password lock is absent &amp; if this location is read it will return <b>One</b>.</li> <li>3) If password lock is present &amp; to disable this lock first send valid password to this location then write "0000" to this location</li> <li>4) If password lock is present &amp; to modify 4X parameter first send valid password to this location so that 4X parameter will be accessible for modification.</li> <li>5) If for in any of the above case invalid password is send then meter will return exceptional error 2.</li> </ol> |
| 40079   | 30mA Noise current Elimination | <p>This address is used to activate or de-activate the 30 mA noise current elimination write</p> <p>0-Deactivate<br/>30 (Decimal)-Activate<br/>Writing any other value will return an error.</p>  |

| Address        | Parameter                     | Description  |
|----------------|-------------------------------|--|
| 40081          | Energy Update Rate            | Energy Update Rate is the time after which energy registers are updated. This time is user settable from 1 - 60 minutes.   |
| 40083          | Model Number                  | This Address is Read Only. This Address shows the Model Number of the meter  |
| 40085          | Brightness                    | This Address is to read and set brightness of LCD Display. The Valid range is 2 to 85. Default value is 42.  |
| 40087          | Contrast                      | This Address is to read and set contrast of LCD Display. The Valid range is 6 to 23. Default value is 9.   |
| 40089 to 40105 | RGB Color Code for L1, L2, L3 | This addresses allow to read or set the value of Red, Green, Blue component of color used to display phase 1, phase 2, phase 3 parameters respectively.<br>Default value for phase 1 : 160, 82, 45; phase 2 : 0, 0, 0 and phase 3 : 128, 128, 128. The valid range is 0 to 255.  |
| 40107 to 40117 | Energy Start Count            | The user can set respective energy starting count in these registers (before the user can write values to these locations user needs to check register 40005 i.e Energy on RS485 and register 40036 i.e Energy digit reset count). Valid range is 0-9999999. For E.g if Energy on RS485 is in K and Energy digit reset count is 7 the start count should be in k and value should be less than 7 digits. |
| 40119 to 40129 | Energy Overflow Start Count   | The user can set respective Energy Overflow starting count in these registers. Valid range is 0-999999.  |

**Table 6 : RS 485 Set-up Code**

| Baud Rate | Parity | Stop Bit | Decimal value | Baud Rate | Parity | Stop Bit | Decimal value |
|-----------|--------|----------|---------------|-----------|--------|----------|---------------|
| 19200     | NONE   | 01       | 12            | 4800      | NONE   | 01       | 04            |
| 19200     | NONE   | 02       | 13            | 4800      | NONE   | 02       | 05            |
| 19200     | EVEN   | 01       | 14            | 4800      | EVEN   | 01       | 06            |
| 19200     | ODD    | 01       | 15            | 4800      | ODD    | 01       | 07            |
| 9600      | NONE   | 01       | 08            | 2400      | NONE   | 01       | 00            |
| 9600      | NONE   | 02       | 09            | 2400      | NONE   | 02       | 01            |
| 9600      | EVEN   | 01       | 10            | 2400      | EVEN   | 01       | 02            |
| 9600      | ODD    | 01       | 11            | 2400      | ODD    | 01       | 03            |

**NOTE :**

Codes not listed in the table above may give rise to unpredictable results including loss of communication. Excise caution when attempting to change mode via direct Modbus writes.

**Table 7 : Pulse1 & Pulse2 Configuration select**

| Code | Configuration          |
|------|------------------------|
| 0    | Import Active Energy   |
| 1    | Export Active Energy   |
| 2    | Import Reactive Energy |
| 3    | Export Reactive Energy |
| 4    | Apparent Energy        |



## 8. Phaser Diagram :

**Quadrant 1:**  $0^\circ$  to  $90^\circ$

**Quadrant 2:**  $90^\circ$  to  $180^\circ$

**Quadrant 3:**  $180^\circ$  to  $270^\circ$

**Quadrant 4:**  $270^\circ$  to  $360^\circ$

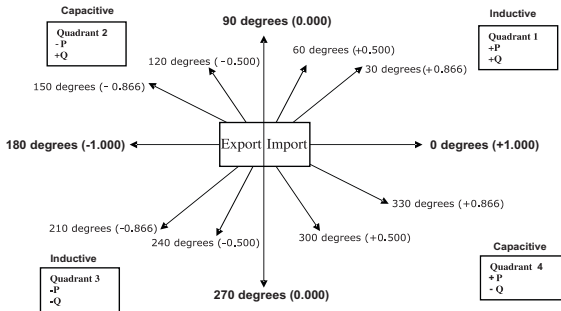

| Connections | Quadrant | Sign of Active Power ( P ) | Sign of Reactive Power ( Q ) | Sign of Power Factor ( PF ) | Inductive / Capacitive |
|-------------|----------|----------------------------|------------------------------|-----------------------------|------------------------|
| Import      | 1        | + P                        | + Q                          | +                           | L                      |
| Import      | 4        | + P                        | - Q                          | +                           | C                      |
| Export      | 2        | - P                        | + Q                          | -                           | C                      |
| Export      | 3        | - P                        | - Q                          | -                           | L                      |

**Inductive means Current lags Voltage**  
**Capacitive means Current leads Voltage**

When the instrument displays Active power ( P )with “ + ” ( positive sign ) ,  
the connection is “ **Import** ” .

When the instrument displays Active power ( P )with “ - ” ( negative sign ) ,  
the connection is “ **Export** ” .

## 9. Installation

Mounting is by four side clamps, slide the side clamps through side slot till side clamp gets firmly locked in a groove (Refer fig.) Consideration should be given to the space required behind the instrument to allow for bends in the connection cables.

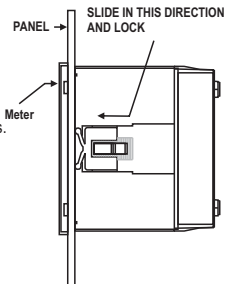

As the front of the enclosure conforms to IP54 it is protected from water spray from all directions, additional protection to the panel may be obtained by the use of an optional panel gasket. The terminals at the rear of the product should be protected from liquids.

The instrument should be mounted in a reasonably stable ambient temperature and where the operating temperature is within the range -10 to 55 °C . Vibration should be kept to a minimum and the product should not be mounted where it will be subjected to excessive direct sunlight.

## Caution

1. **In the interest of safety and functionality this product must be installed by a qualified engineer, abiding by any local regulations.**
2. **Voltages dangerous to human life are present at some of the terminal connections of this unit. Ensure that all supplies are de-energised before attempting any connection or disconnection.**
3. **These products do not have internal fuses therefore external fuses must be used to ensure safety under fault conditions.**

## 9.1 EMC Installation Requirements

This product has been designed to meet the certification of the EU directives when installed to a good code of practice for EMC in industrial environments, e.g.

1. Screened output and low signal input leads or have provision for fitting RF suppression components, such as ferrite absorbers, line filters etc., in the event that RF fields cause problems.

**Note:** It is good practice to install sensitive electronic instruments that are performing critical functions, in EMC enclosures that protect against electrical interference which could cause a disturbance in function.

2. Avoid routing leads alongside cables and products that are, or could be, a source of interference.
3. To protect the product against permanent damage, surge transients must be limited to 2kV pk. It is good EMC practice to suppress differential surges to 2kV at the source. The unit has been designed to automatically recover in the event of a high level of transients. In extreme circumstances it may be necessary to temporarily disconnect the auxiliary supply for a period of greater than 5 seconds to restore correct operation.

The Current inputs of these products are designed for connection in to systems via Current Transformers only, where one side is grounded.

4. ESD precautions must be taken at all times when handling this product.

## 9.2 Case Dimension and Panel Cut Out

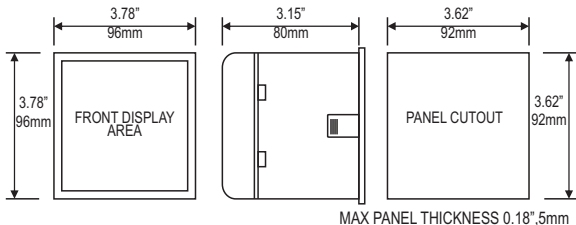

## 9.3 Wiring

Input connections are made directly to screw-type terminals with indirect wire pressure. Numbering is clearly marked in the plastic moulding. Choice of cable should meet local regulations. Terminal for both Current and Voltage inputs will accept upto  $3\text{mm} \times 2$  diameter cables.

**Note : It is recommended to use wire with lug for connection with meter.**

## 9.4 Auxiliary Supply

The instrument should ideally be powered from a dedicated supply, however it may be powered from the signal source, provided the source remains within the limits of the chosen auxiliary voltage.

## 9.5 Fusing

It is recommended that all voltage lines are fitted with 1 amp HRC fuses.

## 9.6 Earth/Ground Connections

For safety reasons, CT secondary connections should be grounded in accordance with local regulations.

## 10. Connection Diagrams

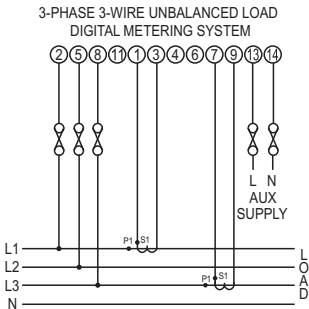

3-PHASE 4-WIRE UNBALANCED LOAD  
DIGITAL METERING SYSTEM

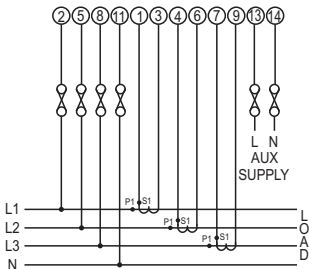

SINGLE PHASE  
DIGITAL METERING SYSTEM

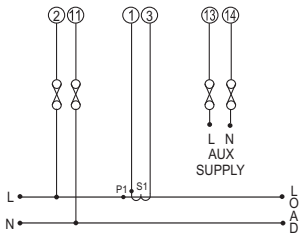

## 11. Specification :

### System

3 Phase 3 Wire / 3 phase 4 Wire programmable at site

1 Phase 2 Wire as per order

### Inputs

|                                  |   |
|----------------------------------|---|
| Nominal input voltage (AC RMS)   | Phase-Neutral 57.7 - 346 $V_{L-N}$<br>Line-Line 100 - 600 $V_{L-L}$       |
| Max continuous input voltage     | 120% of Rated Value   |
| Max short duration input voltage | 2 x Rated Value<br>(1s application repeated 10 times<br>at 10s intervals) |
| Nominal input voltage burden     | 0.35VA approx. per phase  |
| Nominal input current            | 1A / 5A AC rms  |
| Max continuous input current     | 120% of Rated Value   |
| Nominal input current burden     | 0.3 VA approx. per phase  |
| Max short duration current input | 20 x Rated Value (1s application repeated<br>5 times at 5 min. intervals) |
| System CT primary values         | Std. Values from 1 to 9999A<br>(1 or 5 Amp secondaries)                   |

### Auxiliary

|  |  |
|--|--|
| Standard nominal Auxillary supply voltages & Frequency | 60 - 300 V AC- DC OR<br>65 - 300 V AC- DC with Ethernet / Analog Output<br>12 - 60 V AC - DC |
| a.c. supply frequency range                            | 45 to 66 Hz  |
| a.c. supply burden                                     | 6.5 VA approx.<br>8 VA approx. with Ethernet / Analog Output                                 |
| d.c. supply burden                                     | 5.5 W approx.<br>7 W approx. with Ethernet Output  |

## Operating Measuring Ranges

|              |                            |
|--------------|----------------------------|
| Voltage      | 10 .. 120 % of Rated Value |
| Current      | 5 .. 120 % of Rated Value  |
| Frequency    | 40 .. 70 Hz                |
| Power Factor | 0.5 Lag ... 1 ... 0.8 Lead |

## Accuracy

### Accuracy 1:

|                           |                           |
|---------------------------|---------------------------|
| Voltage                   | ± 0.5 % of range          |
| Current                   | ± 0.5 % of range          |
| Frequency                 | ± 0.15% of mid frequency  |
| Active Power              | ± 0.5 % of range          |
| Re- Active Power          | ± 0.5 % of range          |
| Apparent Power            | ± 0.5 % of range          |
| Active Energy             | ± 1.0 % of range          |
| Re - Active Energy        | ± 1.0 % of range          |
| Apparant Energy           | ± 1.0 % of range          |
| Power Factor              | ± 1 % of Unity            |
| Angle                     | ± 1 % of range            |
| Analog Output             | ± 1 % of Output end value |
| Total Harmonic Distortion | ± 1 %                     |
| Neutral Current           | ± 4 % of range.           |

### Accuracy 0.5:

|                  |                          |
|------------------|--------------------------|
| Voltage          | ± 0.5 % of range         |
| Current          | ± 0.5 % of range         |
| Frequency        | ± 0.15% of mid frequency |
| Active Power     | ± 0.5 % of range         |
| Re- Active Power | ± 0.5 % of range         |
| Apparent Power   | ± 0.5 % of range         |
| Active Energy    | ± 0.5 % of range         |



|                           |                           |
|---------------------------|---------------------------|
| Re - Active Energy        | ± 0.5 % of range          |
| Apparent Energy           | ± 0.5 % of range          |
| Power Factor              | ± 1 % of Unity            |
| Angle                     | ± 1 % of range            |
| Analog Output             | ± 1 % of Output end value |
| Total Harmonic Distortion | ± 1 %                     |
| Neutral Current           | ± 4 % of range            |

### **Accuracy 0.2:**

|                           |                           |
|---------------------------|---------------------------|
| Voltage                   | ± 0.2 % of range          |
| Current                   | ± 0.2 % of range          |
| Frequency                 | ± 0.15% of mid frequency  |
| Active Power              | ± 0.2 % of range          |
| Re- Active Power          | ± 0.4 % of range          |
| Apparent Power            | ± 0.2 % of range          |
| Active Energy             | ± 0.2 % of range          |
| Re - Active Energy        | ± 0.5 % of range          |
| Apparant Energy           | ± 0.2 % of range          |
| Power Factor              | ± 1 % of Unity            |
| Angle                     | ± 1 % of range            |
| Analog Output             | ± 1 % of Output end value |
| Total Harmonic Distortion | ± 1 %                     |
| Neutral Current           | ± 4 % of range            |

### **Reference conditions for Accuracy :**

|                            |  |
|----------------------------|--|
| Reference temperature      | 23 °C ± 2 °C   |
| Input frequency            | 50 or 60Hz ± 2%  |
| Input waveform             | Sinusoidal (distortion factor 0.005)                                 |
| Auxiliary supply voltage   | Rated Value ± 1 %  |
| Auxiliary supply frequency | Rated Value ± 1 %  |
| Voltage Range              | 50... 100% of Nominal Value.<br>60... 100% of Nominal Value for THD. |

|                            |  |
|----------------------------|--|
| Current Range              | 10... 100% of Nominal Value.<br>20... 100% of Nominal Value for THD.   |
| Power                      | $\cos\phi / \sin\phi = 1$<br>For Active / Reactive Power & Energy<br>10... 100% of Nominal Current &<br>50... 100% of Nominal Voltage. |
| Power Factor / Phase Angle | 40... 100% of Nominal Current &<br>50... 100% of Nominal Voltage.  |

### **Nominal range of use of influence quantities for measurands**

|  |  |
|--|--|
| Voltage  | 50 .. 120 % of Rated Value   |
| Current  | 10 .. 120 % of Rated Value   |
| Input frequency  | Rated Value $\pm$ 10 %   |
| Temperature  | 0 to 50 °C   |
| Auxiliary supply voltage   | Rated Value $\pm$ 10 %   |
| Auxiliary supply frequency   | Rated Value $\pm$ 10 %   |
| Temperature Coefficient<br>(For Rated value range of use<br>0... 50 °C ) | 0.025% / ° for Voltage (50..120% of Rated Value)<br>0.05% / °C for Current ( 10..120% of Rated Value ) |
| Error change due to variation of an<br>influence quantity                | 2 * Error allowed for the reference<br>condition applied in the test.                                  |

### **Display**

|         |   |
|---------|---|
| TFT LCD | 3.5" Graphical LCD, resolution 320x240 pixels |
| Update  | Approx. 1 seconds                             |

### **Controls**

|                |                        |
|----------------|------------------------|
| User Interface | Resistive Touch screen |
|----------------|------------------------|

## Standards

EMC Immunity

IEC 61326

10V/m min-Level 3 industrial low level  
electromagnetic radiation environment

IEC 61000-4-3.

IEC 61010-1 , Year 2001

IEC 60529

Safety

IP for water & dust

## Isolation

Dielectric voltage withstand  
test between circuits and  
accessible surfaces

2.2 kV RMS 50 Hz for 1 minute  
between all electrical circuits

## Environmental

Operating temperature

-10 to 55 °C

Storage temperature

-20 to +65 °C

Relative humidity

0 .. 90 % RH

Warm up time

3 minute (minimum)

Shock

15g in 3 planes

Vibration

10 .. 55 Hz, 0.15mm amplitude

Enclosure ( front only )

IP 54 as per IEC 60529

## Enclosure

Style

96mm x 96mm DIN Quadratic

Material

Polycarbonate Housing ,

Terminals

Self extinguish & non dripping as per UL 94 V-0  
Screw-type terminals

Depth

< 80 mm

Weight

0.620 kg Approx.

## Pulse output Option ( 1 or 2 Relay ) :

|                             |   |
|-----------------------------|---|
| Relay                       | 1NO + 1NC   |
| Switching Voltage & Current | 240VDC , 5Amp.  |
| Default Pulse rate Divisor  | 1 per Wh (up to 3600W),<br>1 per kWh (up to 3600kW),<br>1 per MWh (above 3600 kW)             |
| Pulse rate Divisors         | Programmable on site  |
| 10                          | 1 per 10Wh (up to 3600W),<br>1 per 10kWh (up to 3600kW),<br>1 per 10MWh (above 3600 kW)       |
| 100                         | 1 per 100Wh (up to 3600W),<br>1 per 100kWh (up to 3600kW),<br>1 per 100MWh (above 3600 kW)    |
| 1000                        | 1 per 1000Wh (up to 3600W),<br>1 per 1000kWh (up to 3600kW),<br>1 per 1000MWh (above 3600 kW) |
| Pulse Duration              | 60ms , 100ms or 200ms   |

**Note : Above conditions are also applicable for Reactive & Apparent Energy .**

**Note : Pulse rate divisor is set to 1, when Energy on Rs485 is set to kWh or MWh.**

## ModBus ( RS 485 ) Option :

|           |  |
|-----------|--|
| Protocol  | ModBus ( RS 485 )  |
| Baud Rate | 19200 , 9600 , 4800 or 2400<br>( Programmable )                |
| Parity    | Odd or Even, with 1 stop bit,<br>Or None with 1 or 2 stop bits |

## Analog Output Option :

|        |   |
|--------|---|
| Linear | 0 ... 1mA dc into 0 - 2 kohm<br>Uni-directional, internally powered .<br>4 ... 20mA dc into 0 - 500 ohm<br>Uni-directional, internally powered. |
|--------|---|

## 12. Connection for Optional Pulse Output / RS 485 ( rear view of the instrument ) :

### 1. RS 485 Output + One Pulse (One Limit) + Two Analog Output

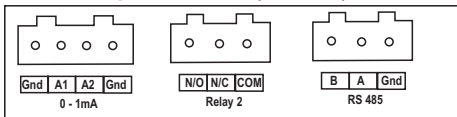

### 2. Two Pulse (Two Limit) + RS 485 Output

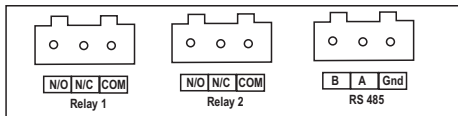

### 3. Ethernet



---

The Information contained in these installation instructions is for use only by installers trained to make electrical power installations and is intended to describe the correct method of installation for this product.

It is the user's responsibility to determine the suitability of the installation method in the user's field conditions.

---